

REPÈRES CP 2019

Prénom de l'élève

Nom de l'élève

Classe de l'élève

SÉQUENCE 1

FRANÇAIS

Exercise 1

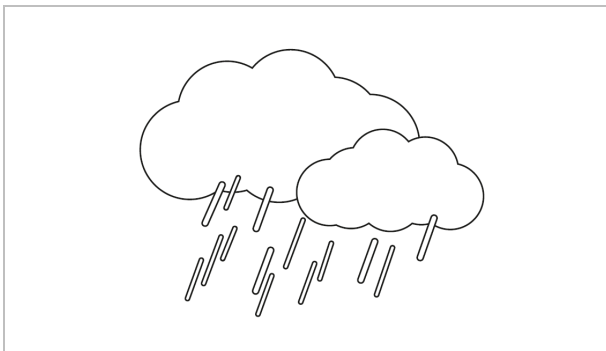
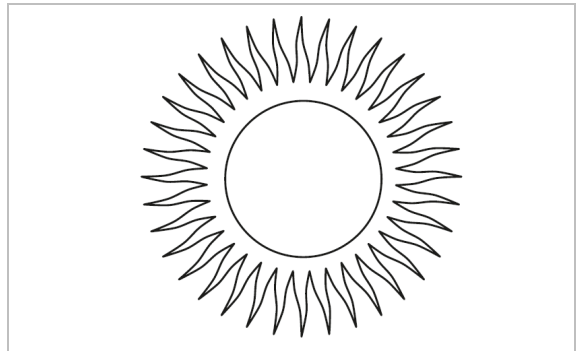
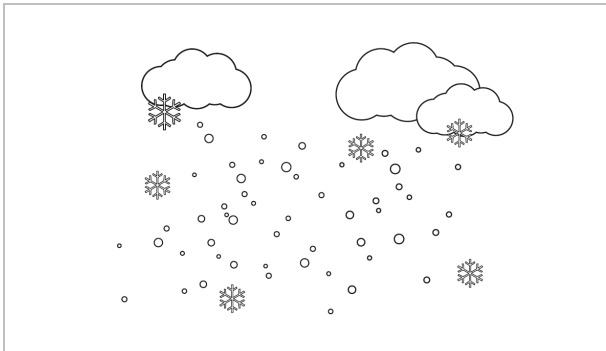
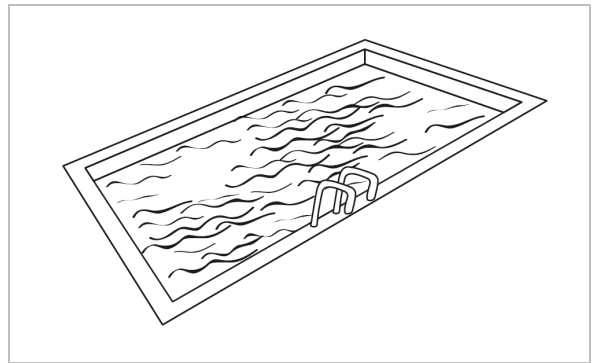
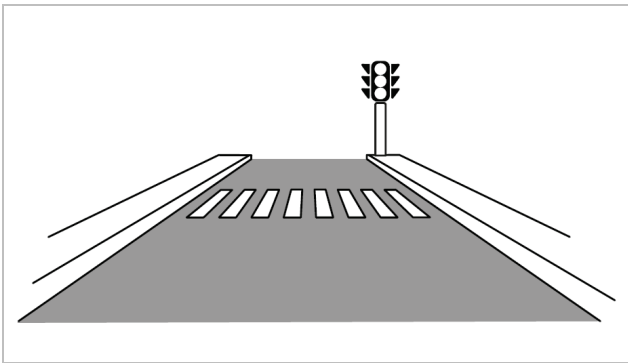

Exercice 1 (suite)

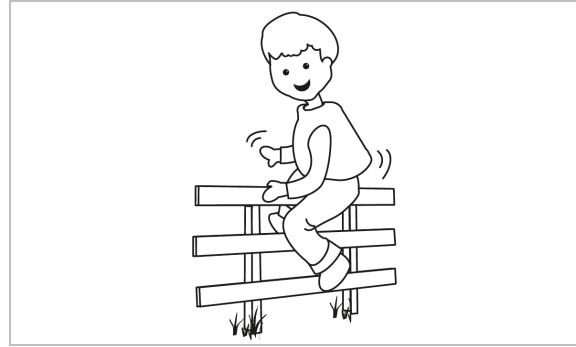
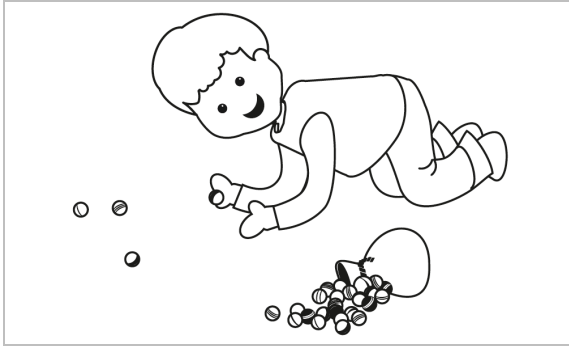

Exercise 2

l f a o G d
f O A i D g
o i F g a d



E b a o C d
b O A e D c
o e B c a d

Exercice 2 (suite)



E **b** **a** *a* **C** **d**

b **O** **A** *e* **D** *c*

o **e** **B** **c** *a* *d*



E **b** **a** *a* **C** **d**

b **O** **A** *e* **D** *c*

o **e** **B** **c** *a* *d*

Exercice 2 (suite)



E **b** **a** *a* **C** **d**

b **O** **A** *e* **D** *c*

o **e** **B** **c** *a* *d*



E **b** **a** *a* **C** **d**

b **O** **A** *e* **D** *c*

o **e** **B** **c** *a* *d*

Exercice 2 (suite)



E **b** **a** *a* **C** **d**

b **O** **A** *e* **D** *c*

o **e** **B** **c** *a* *d*



R **v** **m** *n* **S** **d**

v **N** **M** *n* **D** *b*

n **r** **V** **s** *m* *d*

Exercise 3

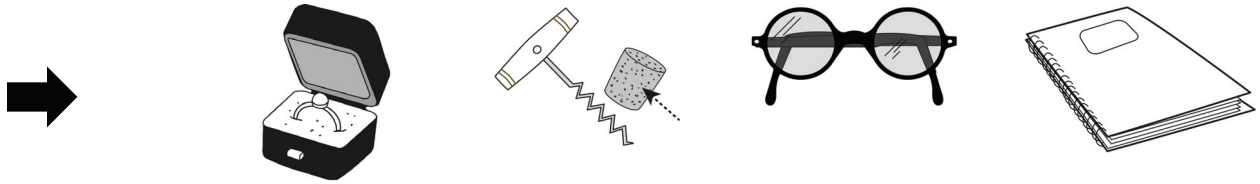
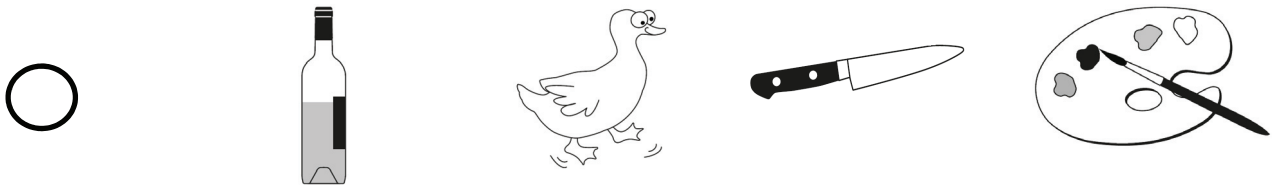
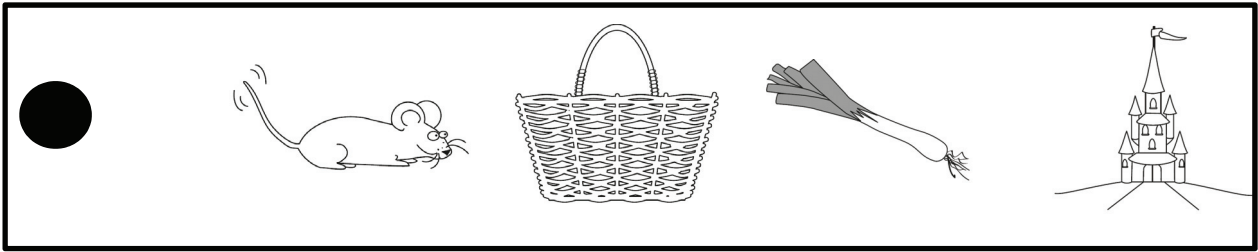

Exercice 3 (suite)

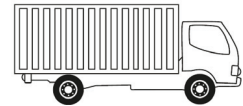
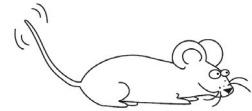
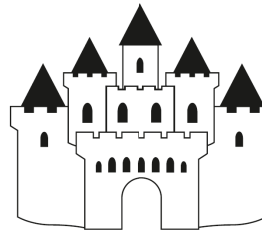
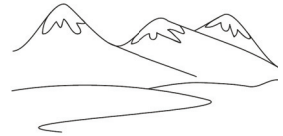
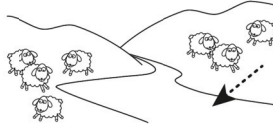
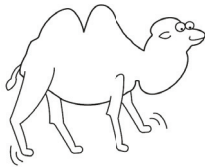
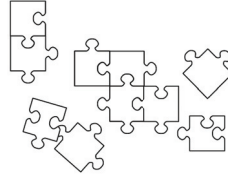
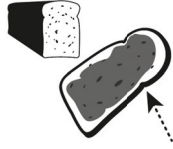

Exercise 4

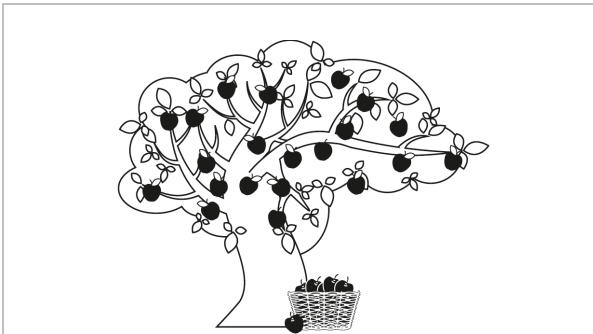
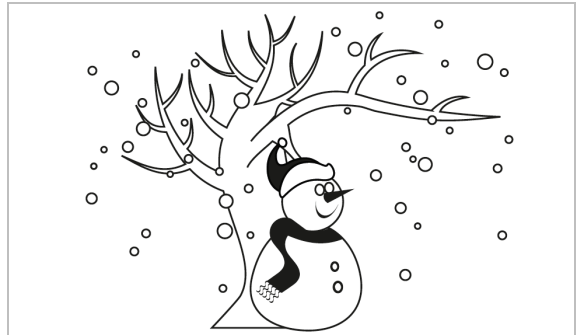
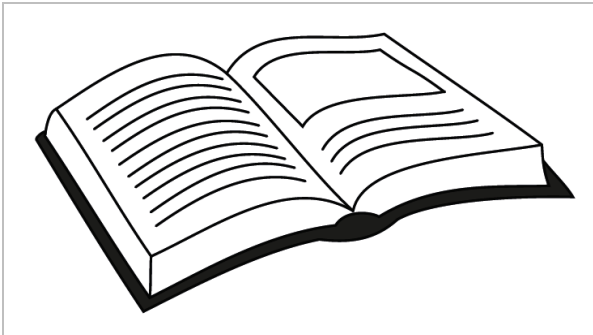
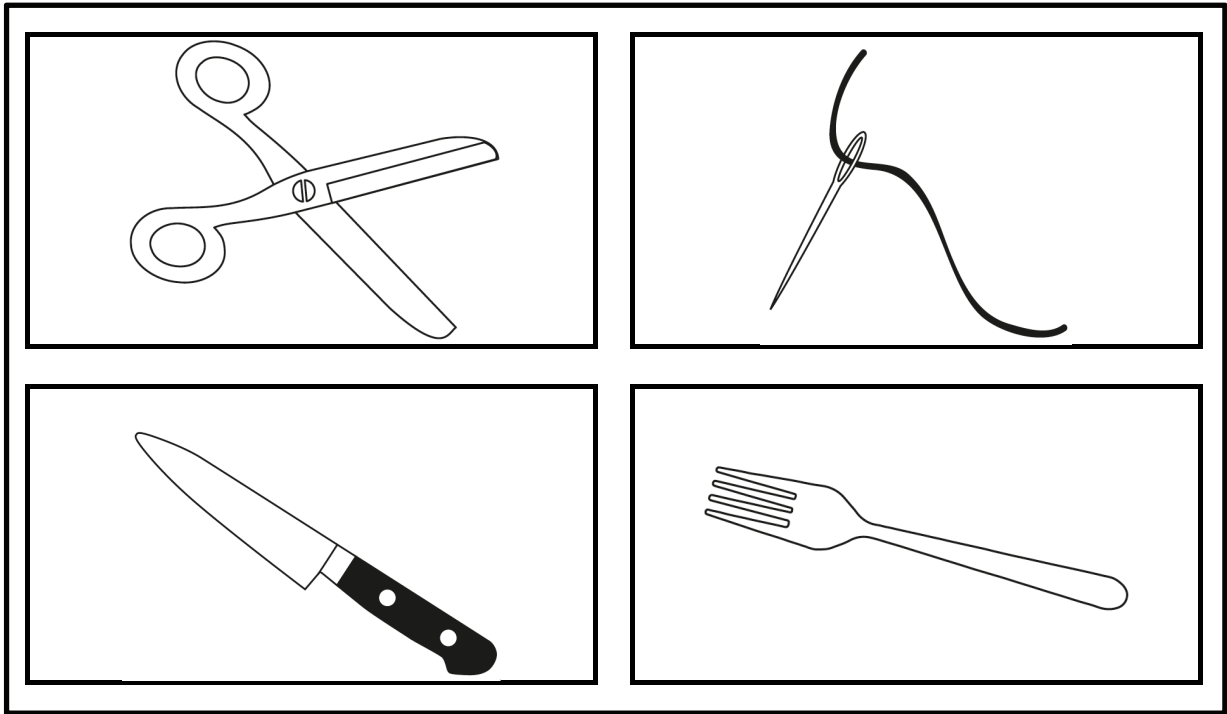

Exercice 4 (suite)

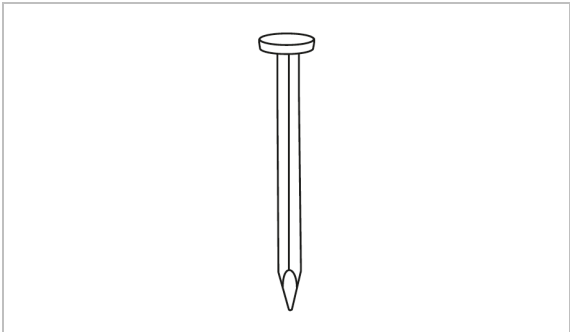
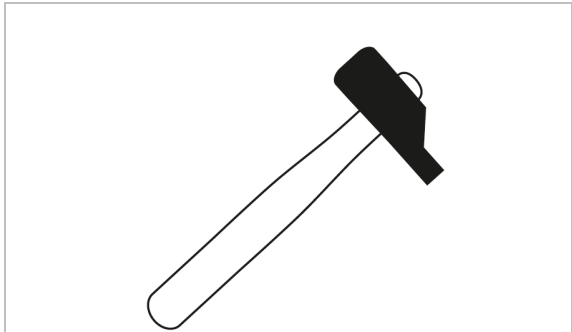
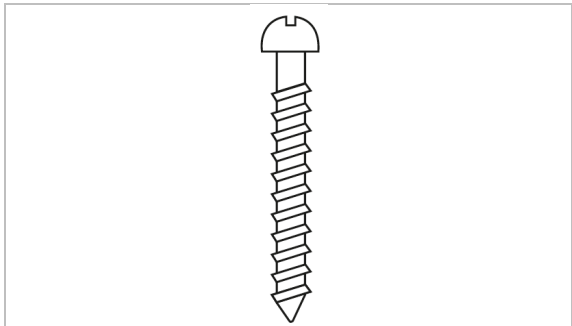
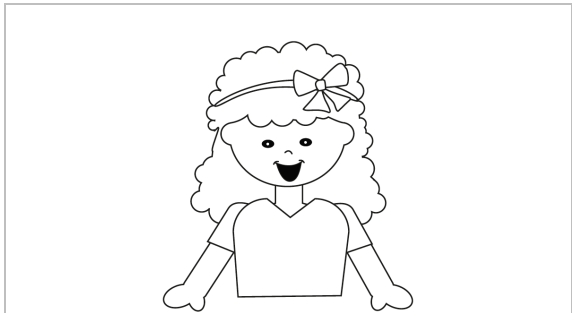

Exercice 4 (suite)

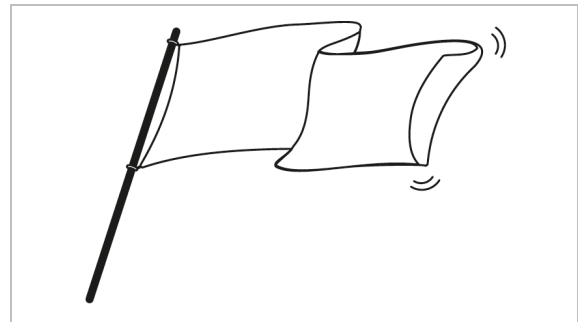
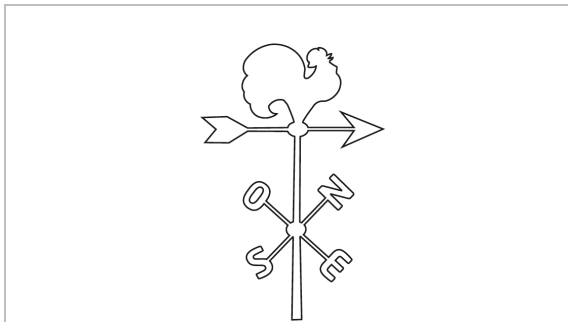
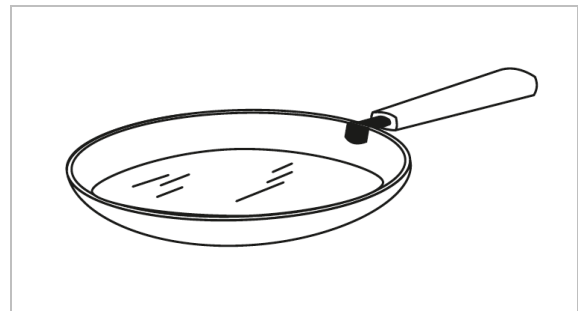
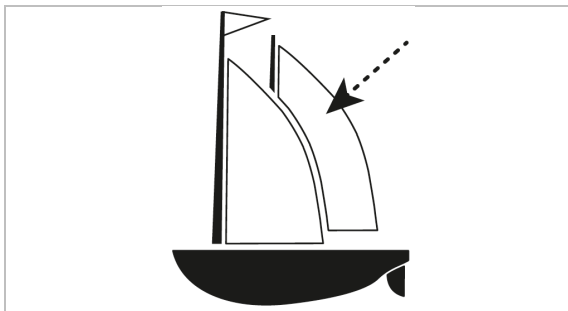
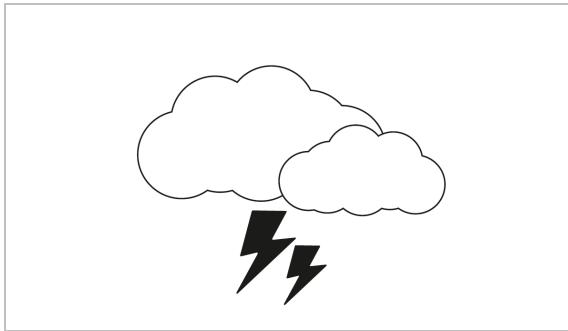
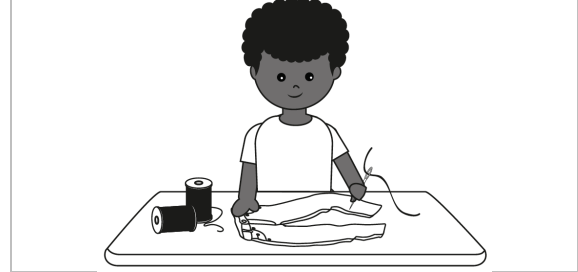
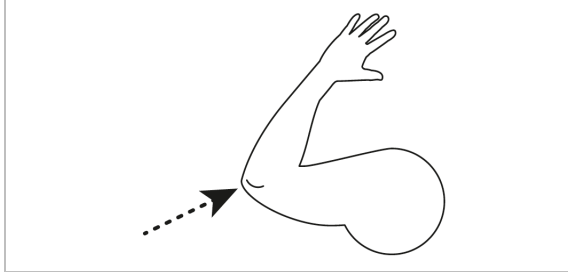

Exercice 4 (suite)

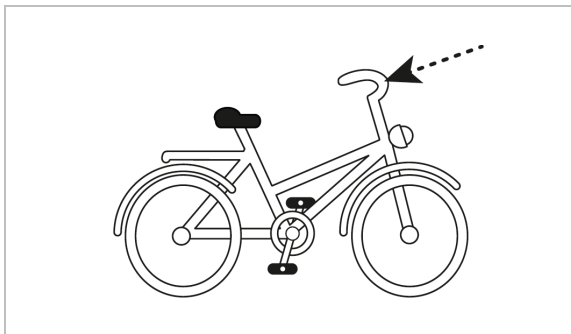
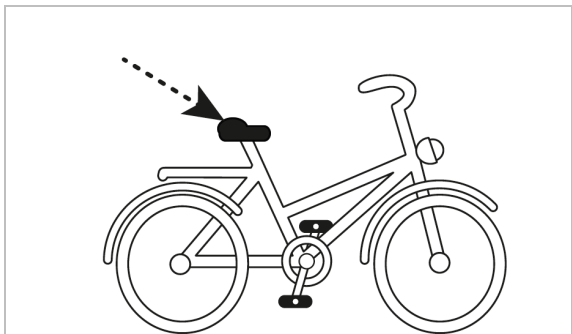
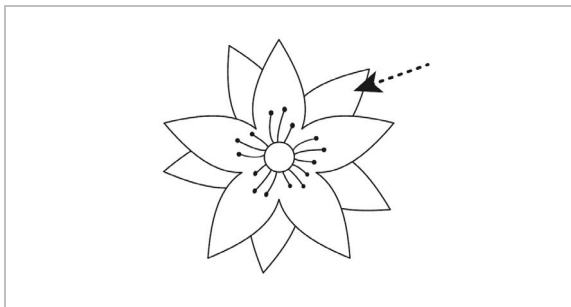
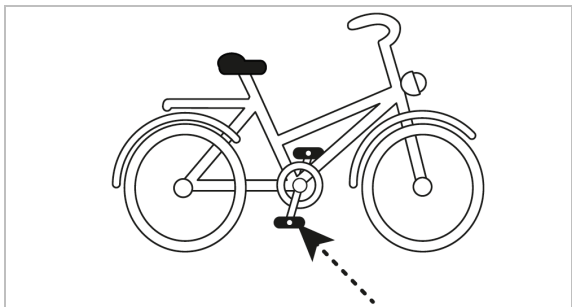
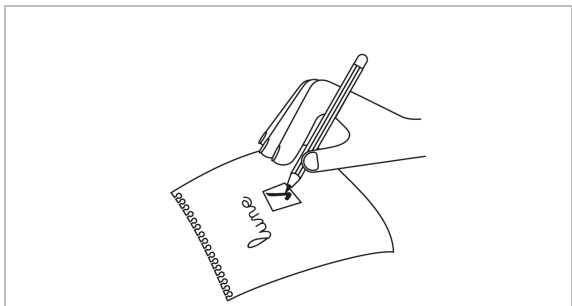
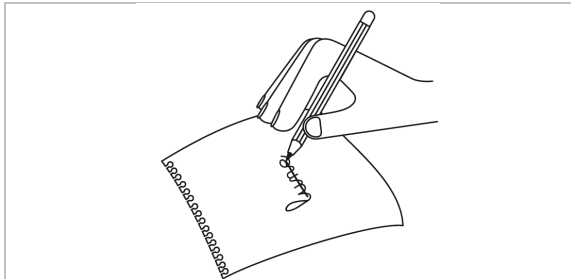
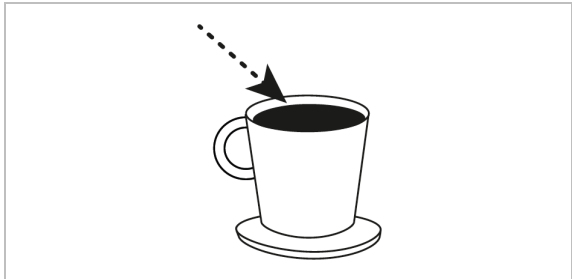

Exercice 4 (suite)

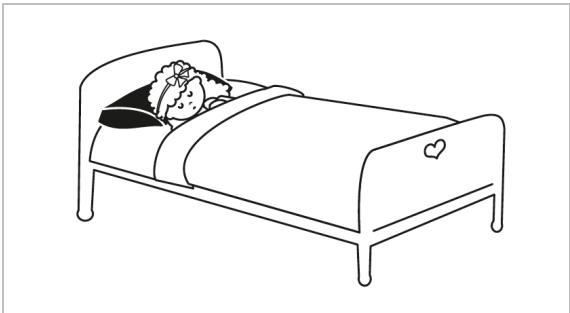
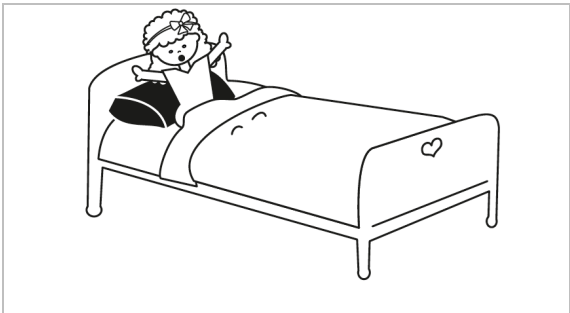
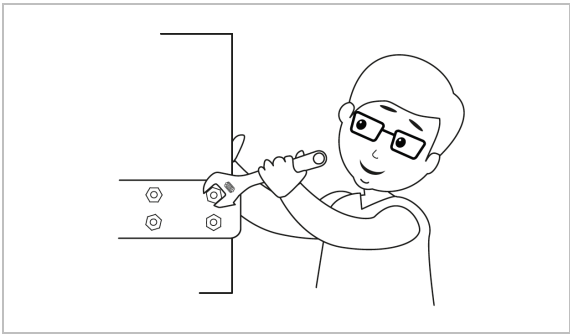
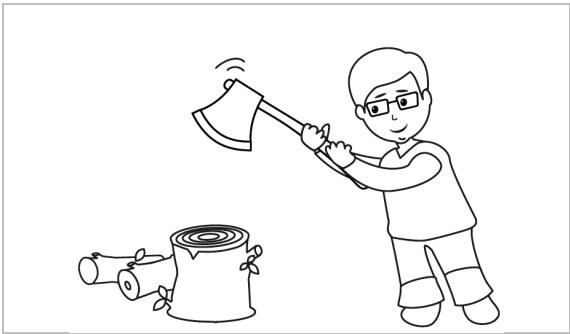
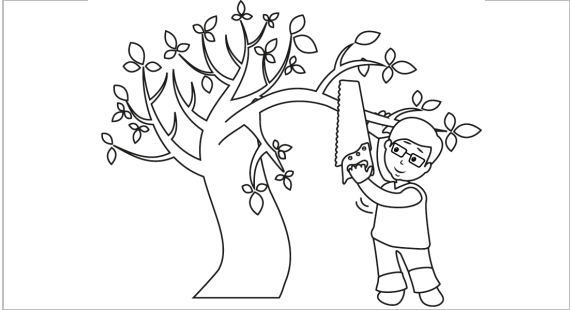
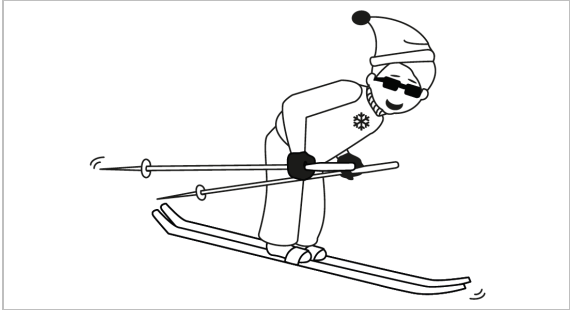

Exercice 4 (suite)

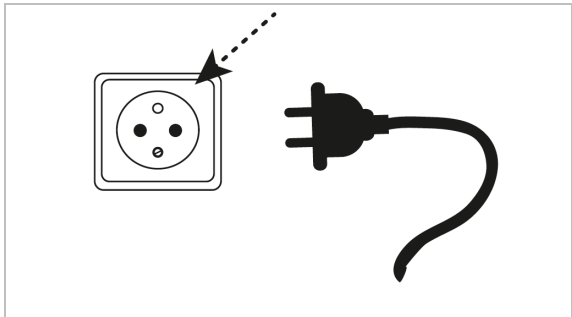
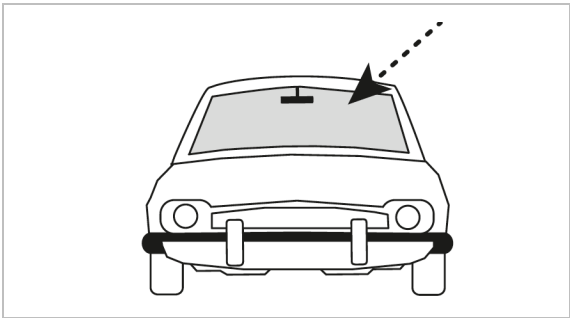
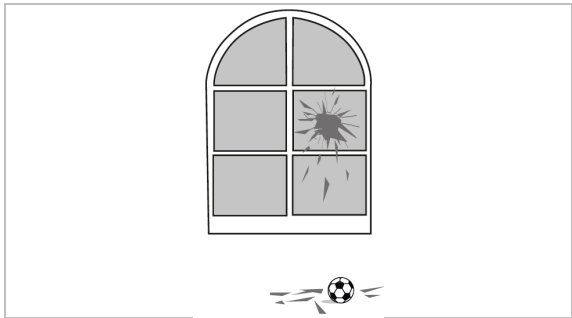
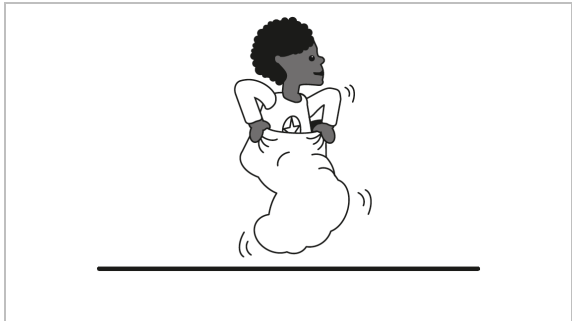
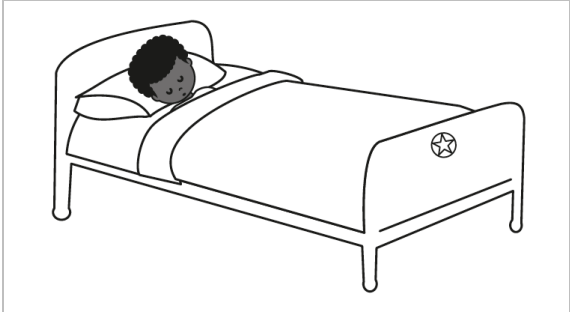

Exercice 4 (suite)

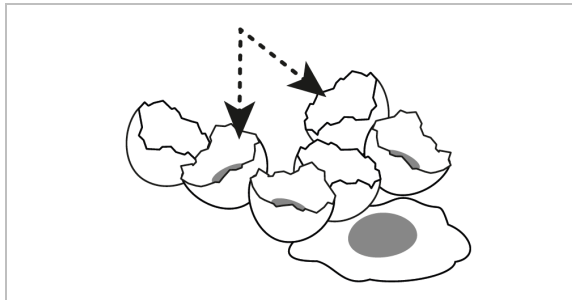
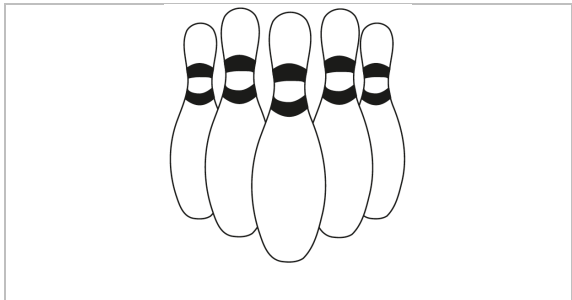
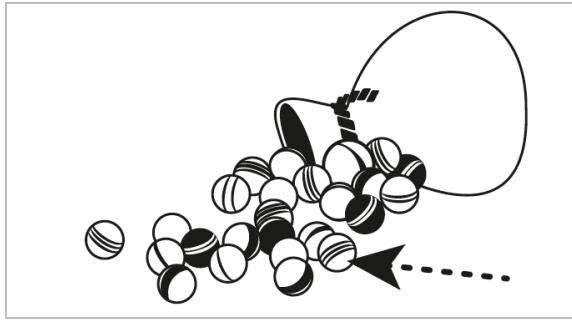
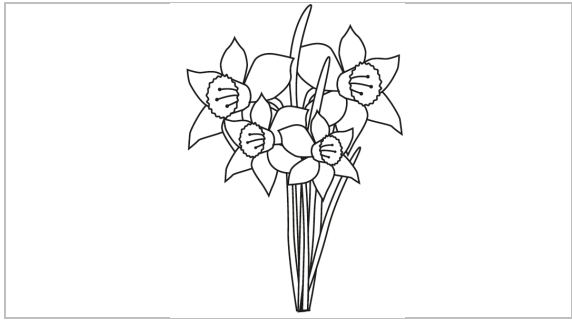
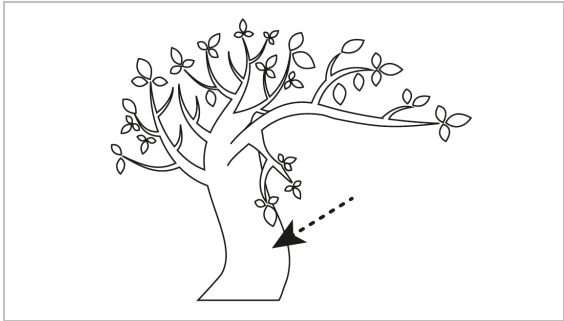
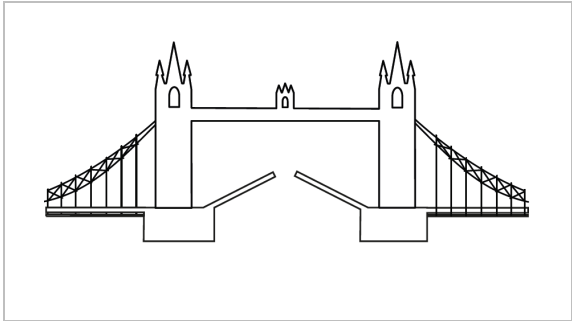
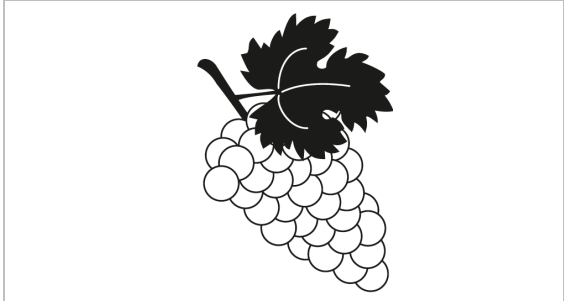
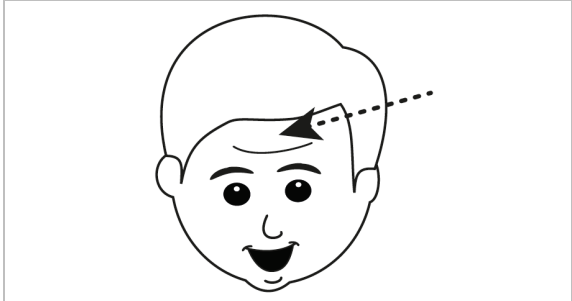

Exercice 4 (suite)

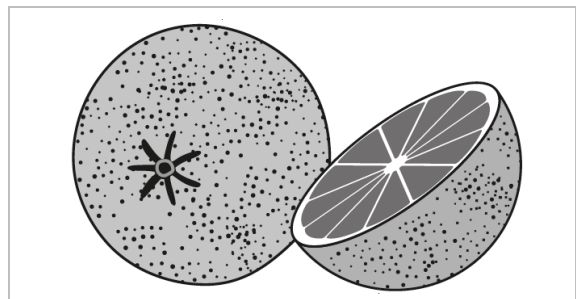
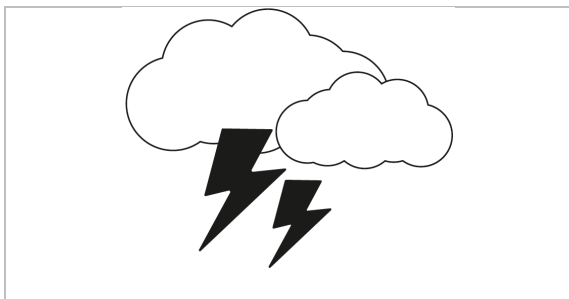
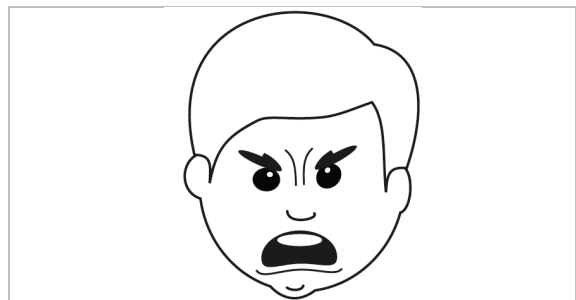
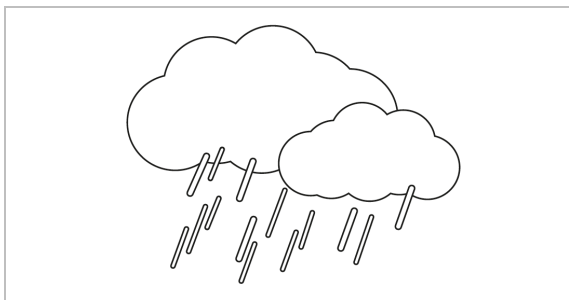
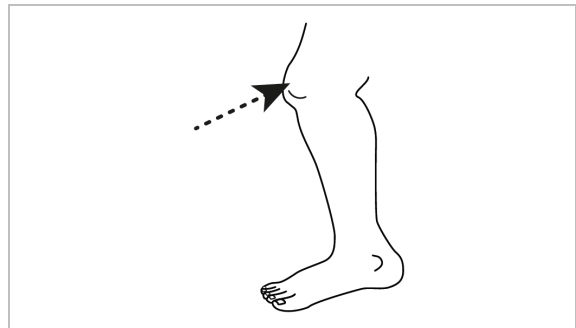
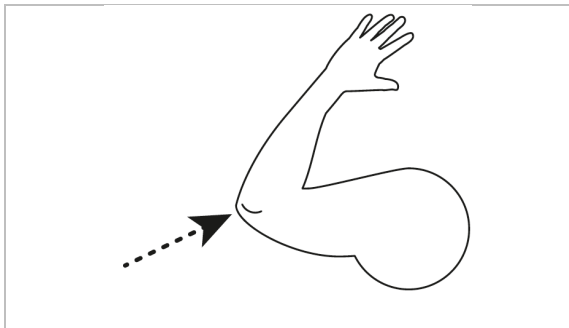
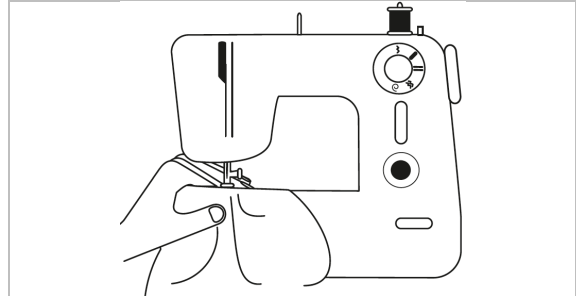
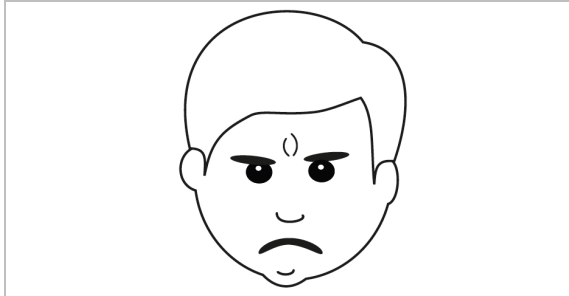

SÉQUENCE 2

MATHÉMATIQUES

Exercice 5

●	2	10	7	1	9	6
---	---	----	---	---	---	---

○	0	6	3	2	5	1
---	---	---	---	---	---	---

➔	7	4	1	3	5	2
---	---	---	---	---	---	---

⇒	2	8	6	0	10	9
---	---	---	---	---	----	---

■	1	10	0	6	8	2
---	---	----	---	---	---	---

□	7	1	2	10	5	3
---	---	---	---	----	---	---

Exercice 5 (suite)

 0 2 9 10 1 7

 0 6 3 2 5 1

 7 4 1 3 5 2

 2 8 6 0 10 9

 0 2 9 10 1 7

Exercice 6

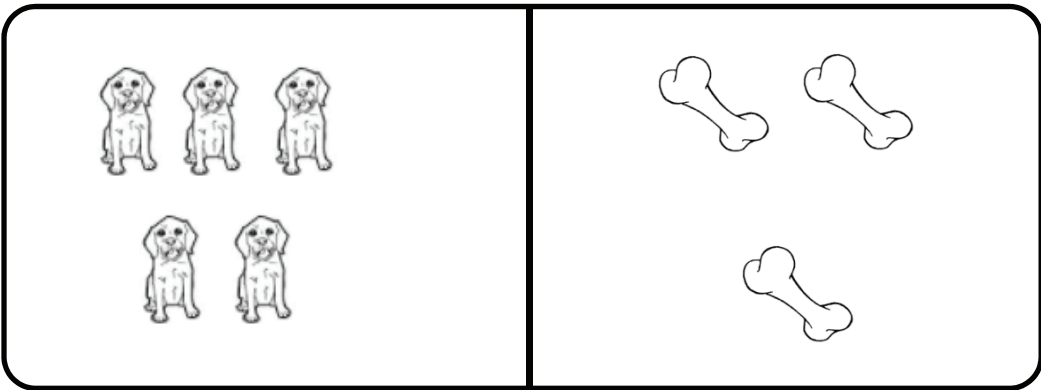

1 2 3 4 5 6

Exercice 6 (suite)

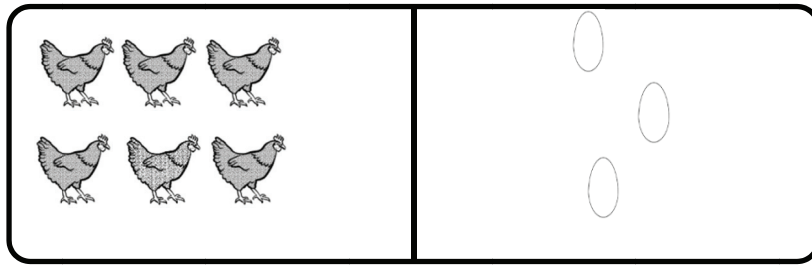

1 2 3 4 5 6

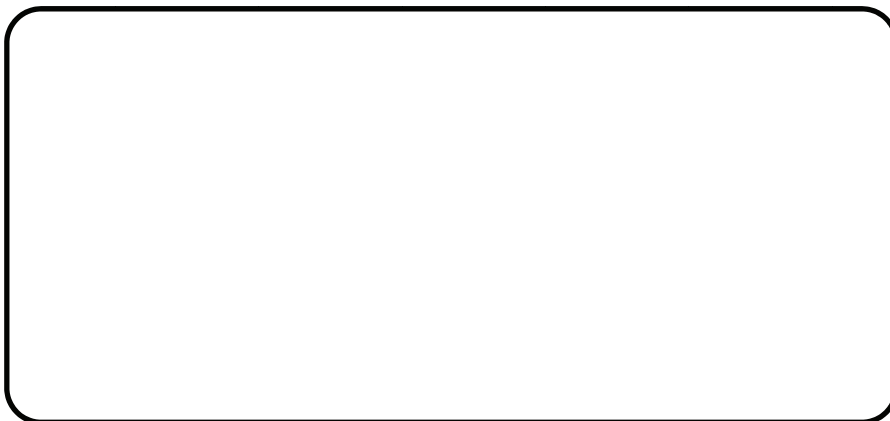
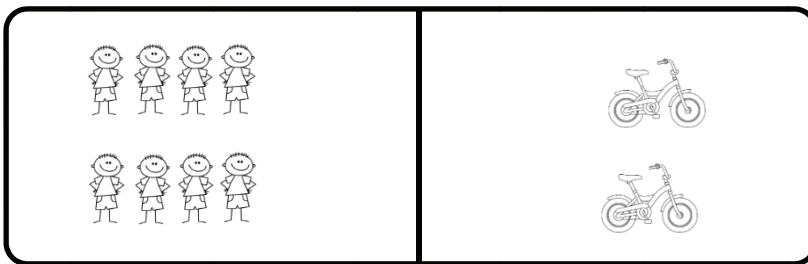

1 2 3 4 5 6

Exercice 6 (suite)

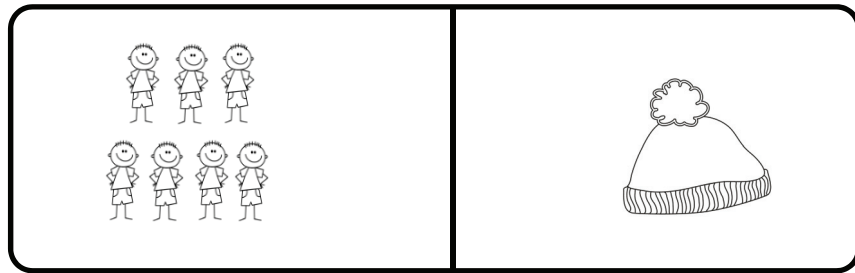

1 2 3 4 5 6

Exercice 7

●



1 2 3 4 5 6 7 8 9 10

○



1 2 3 4 5 6 7 8 9 10

➔



1 2 3 4 5 6 7 8 9 10

Exercice 7 (suite)



1	2	3	4	5	6	7	8	9	10
---	---	---	---	---	---	---	---	---	----



1	2	3	4	5	6	7	8	9	10
---	---	---	---	---	---	---	---	---	----



1	2	3	4	5	6	7	8	9	10
---	---	---	---	---	---	---	---	---	----

Exercice 7 (suite)



1	2	3	4	5	6	7	8	9	10
---	---	---	---	---	---	---	---	---	----



1	2	3	4	5	6	7	8	9	10
---	---	---	---	---	---	---	---	---	----



1	2	3	4	5	6	7	8	9	10
---	---	---	---	---	---	---	---	---	----

Exercice 8

Exemples

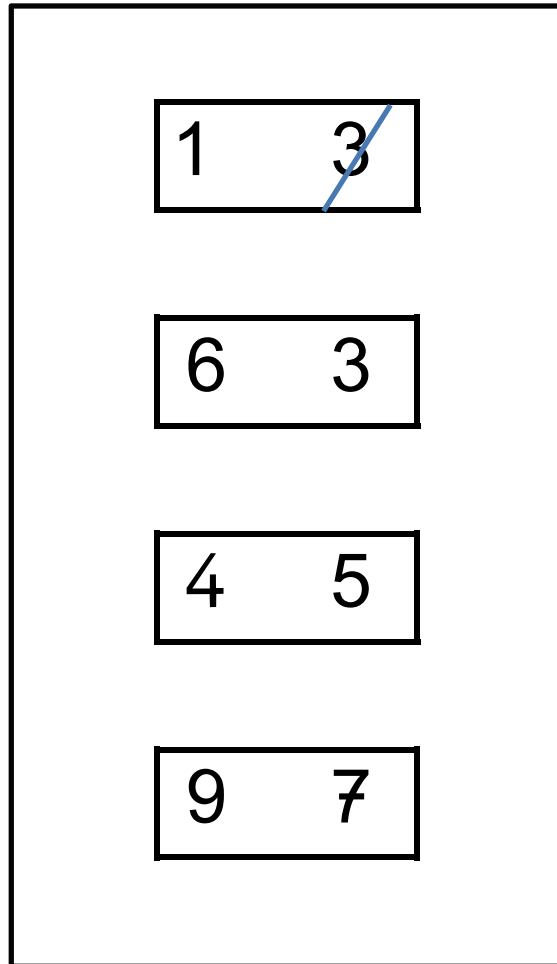

Exercice 8 (suite)

8	9	7	4	5	6	4	1
2	6	5	9	4	3	9	6
5	4	7	6	2	1	5	8
3	2	5	1	9	8	3	4
4	1	8	9	4	5	2	6
2	5	1	4	8	7	5	1
3	6	8	5	2	3	9	8
8	4	1	2	6	7	5	4
6	7	4	3	9	5	1	2
2	1	5	6	4	8	7	6

Exercise 9

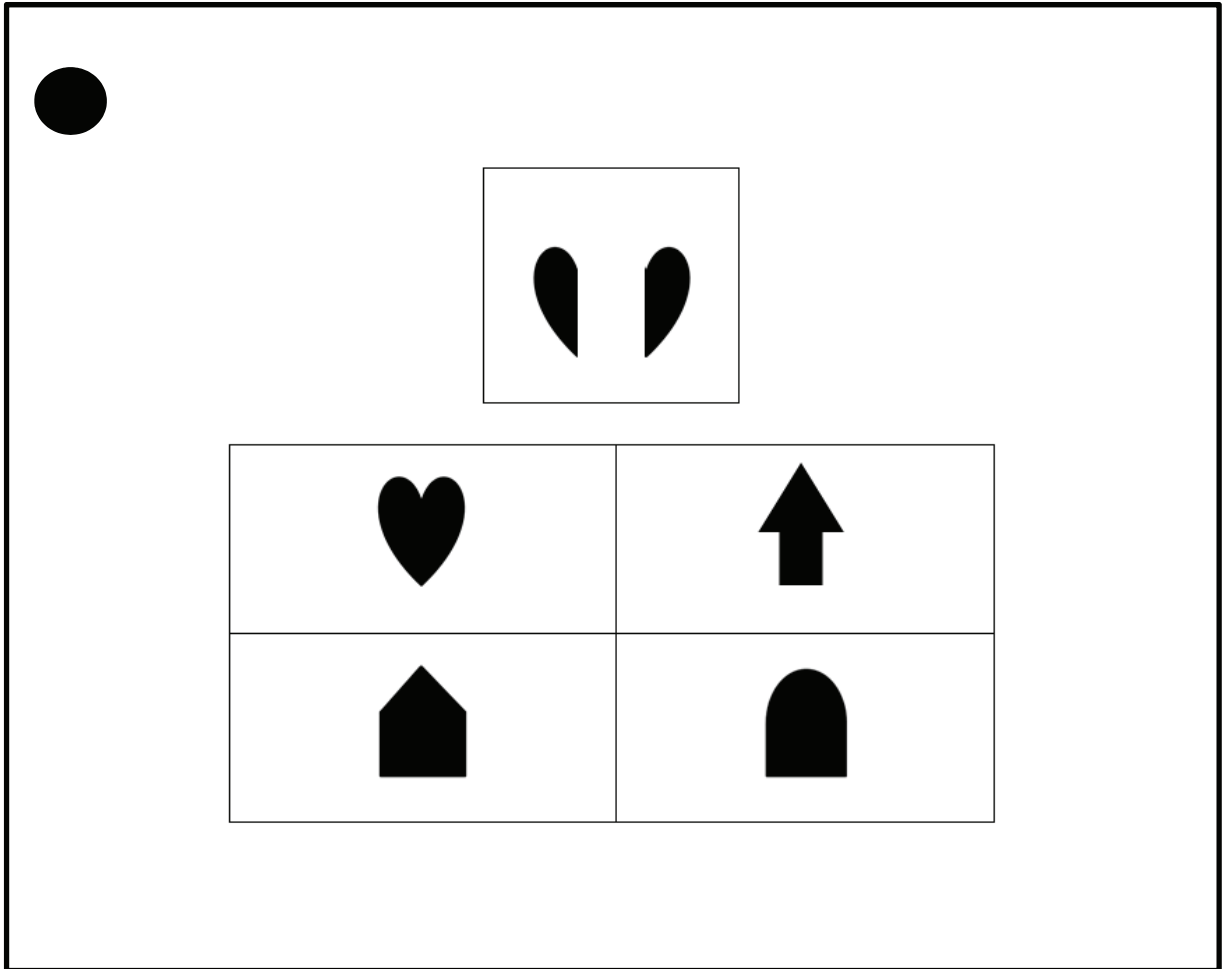

Exercice 9 (suite)

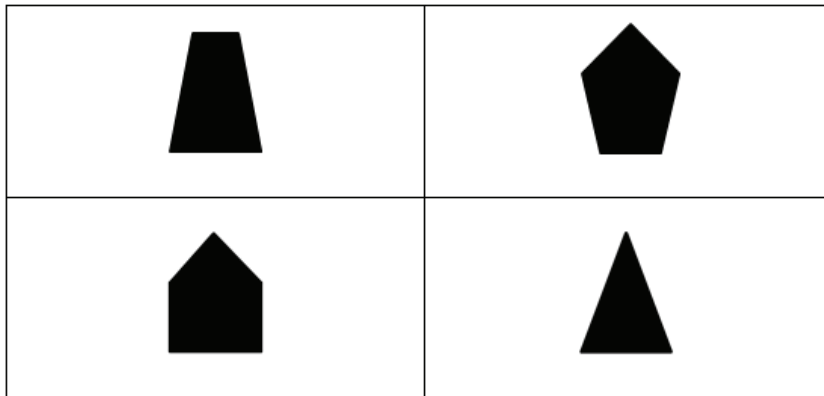
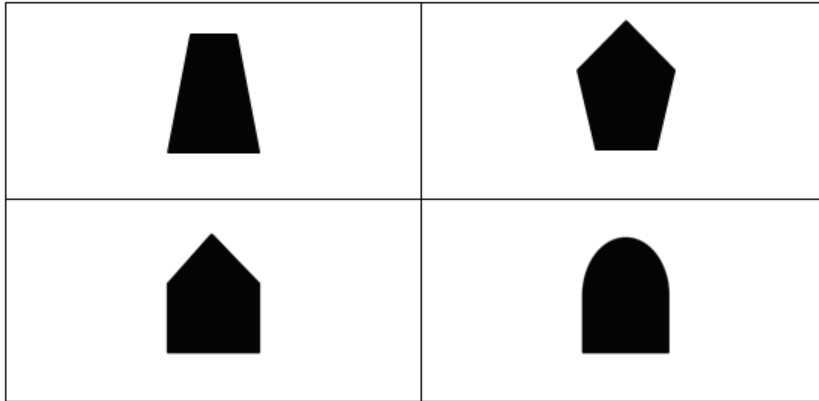
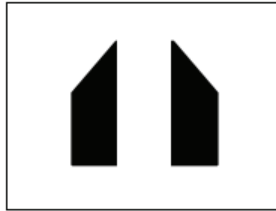

Exercice 9 (suite)

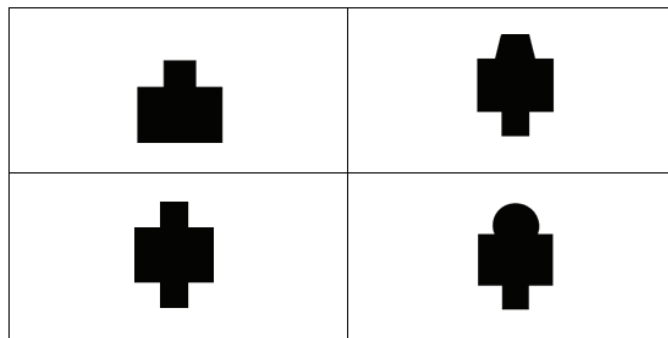
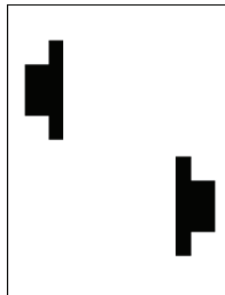
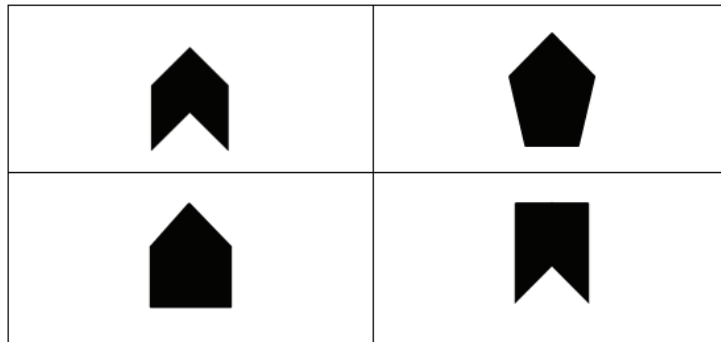
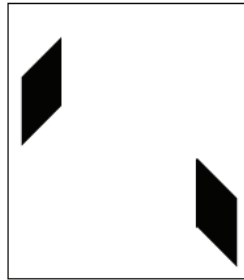



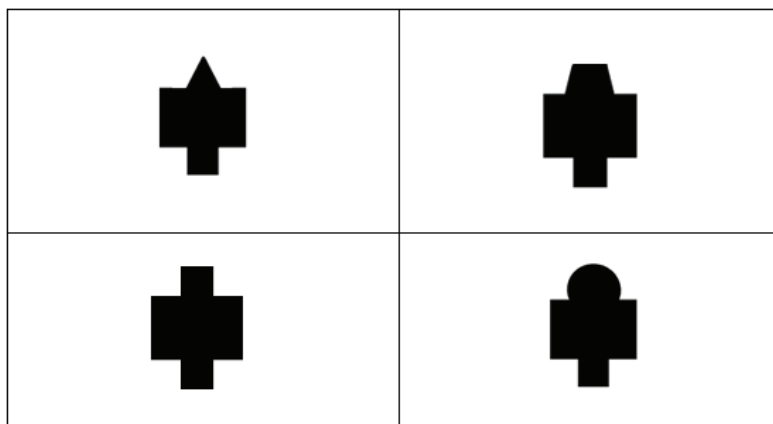
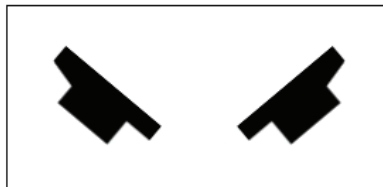
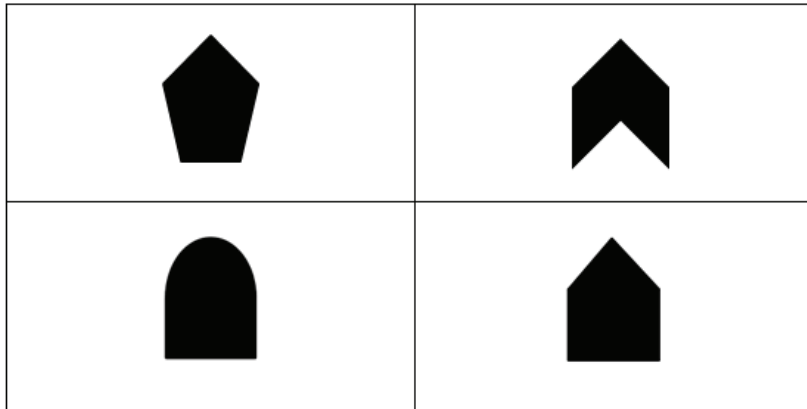
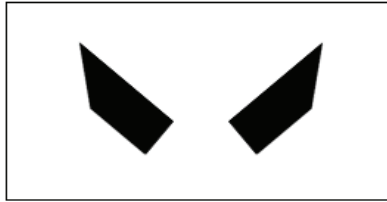

Exercice 9 (suite)

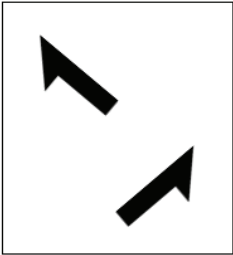





Exercice 9 (suite)

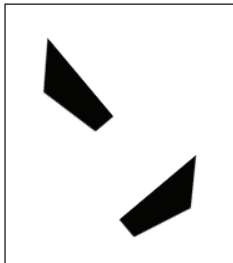



SÉQUENCE 3

FRANÇAIS

Exercice 10

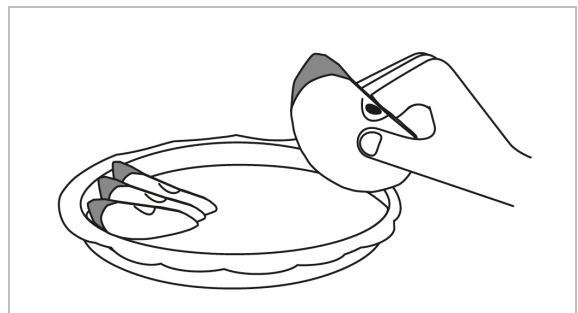
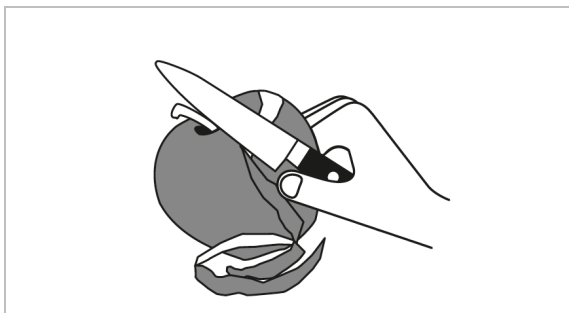
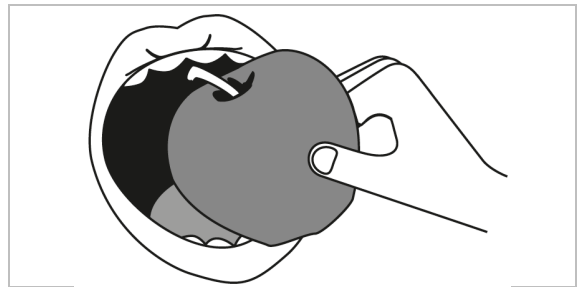
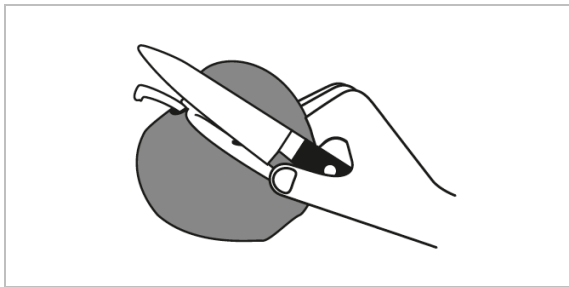
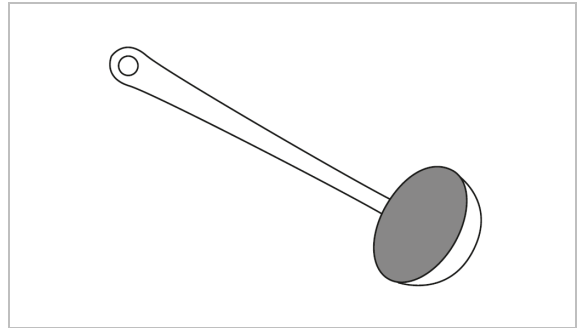
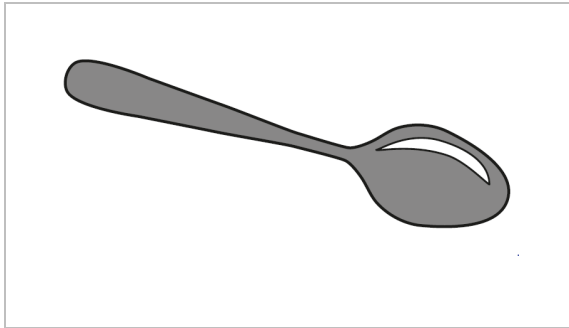
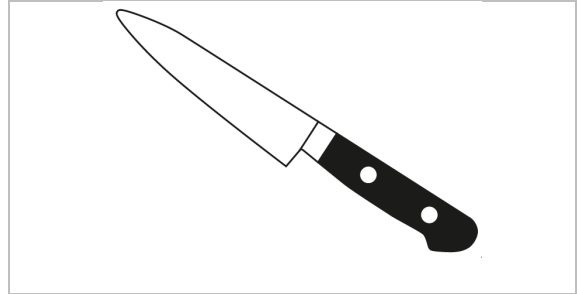
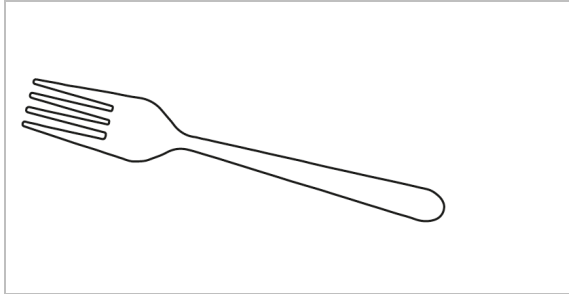

Exercice 10 (suite)

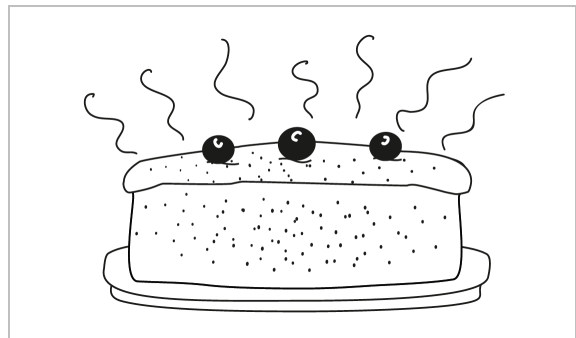
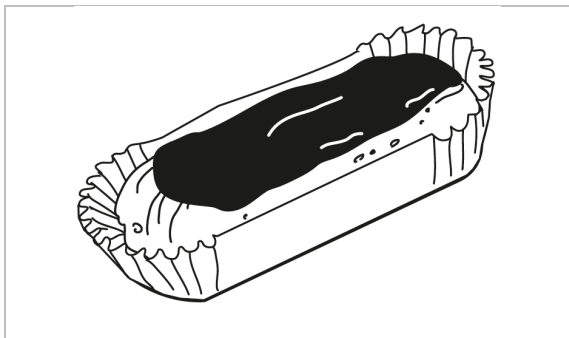
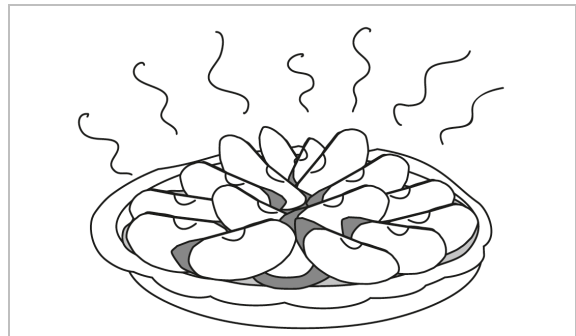
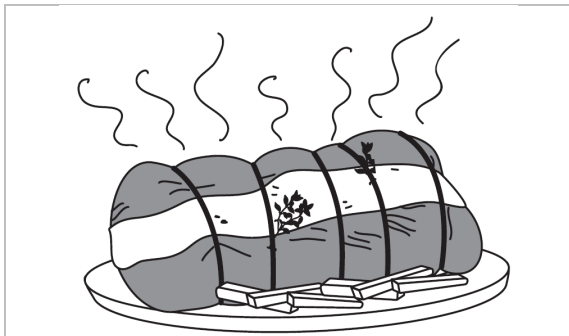
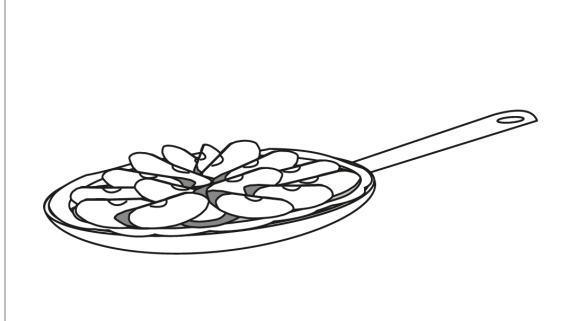

Exercise 11

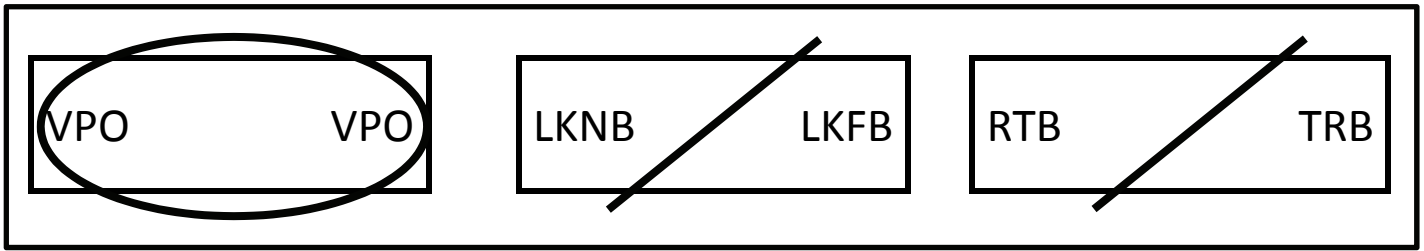

GPD CPD

TGR TGR

LDF DLF

BGTR BCTR

DFEK DEFK

QZM QZM

MZV MZV

SRGVT SRCVT

ZPLC ZPLC

CGNMO CGNMO

BRT BTR

POJZB POJZB

Exercise 12

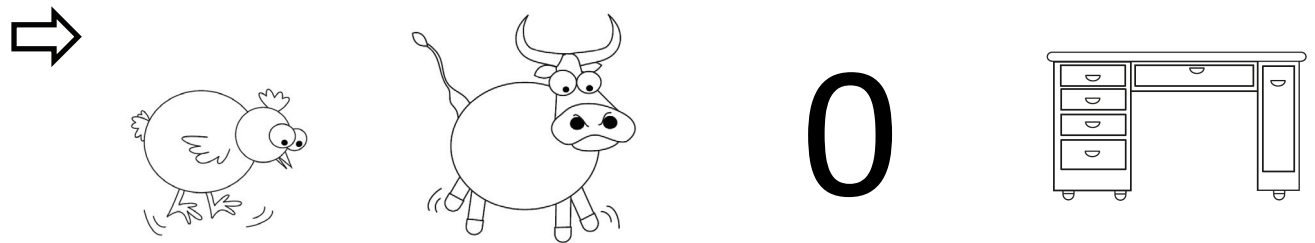
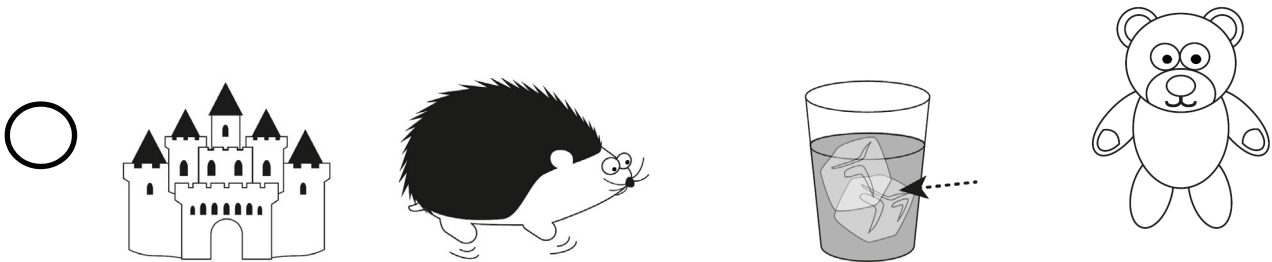
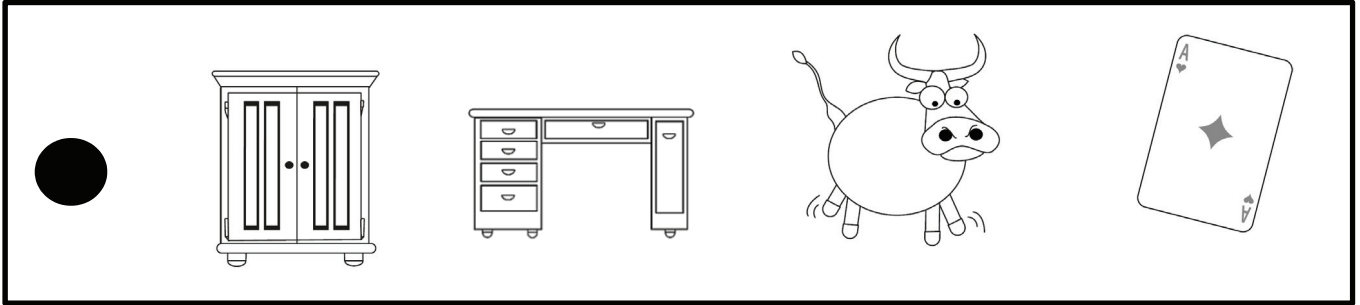

Exercice 12 (suite)

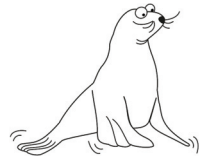
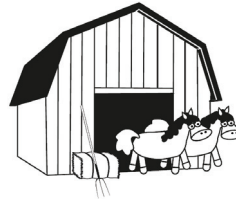
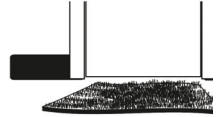
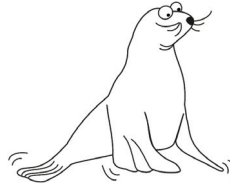

Exercise 13

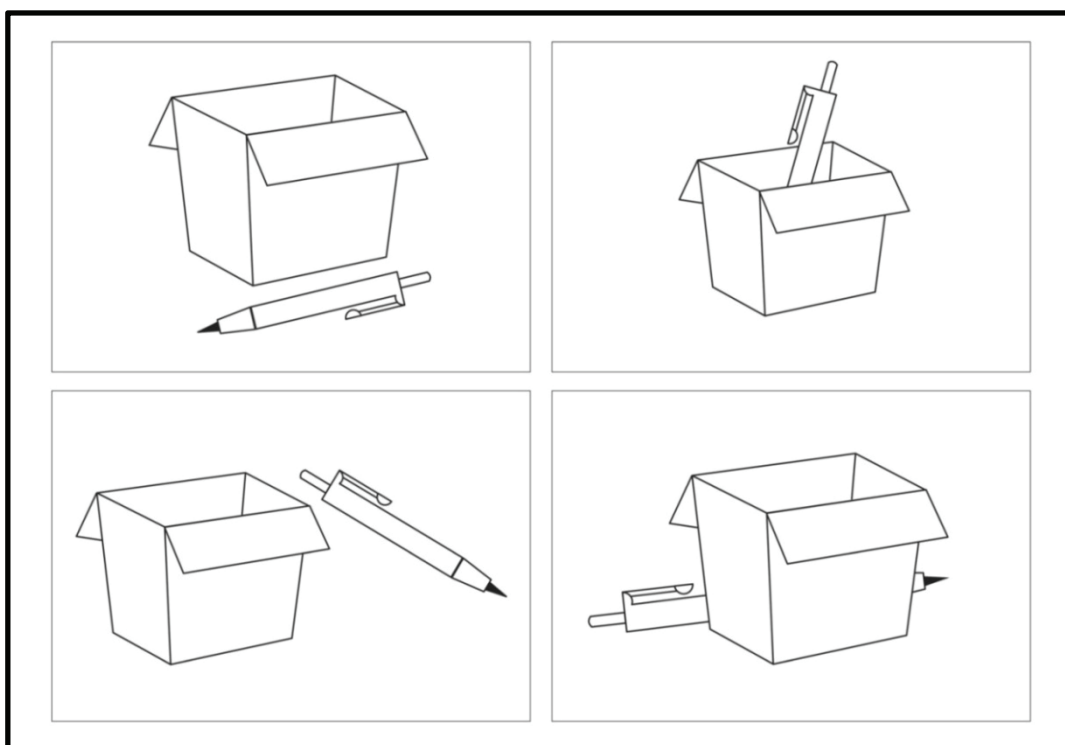
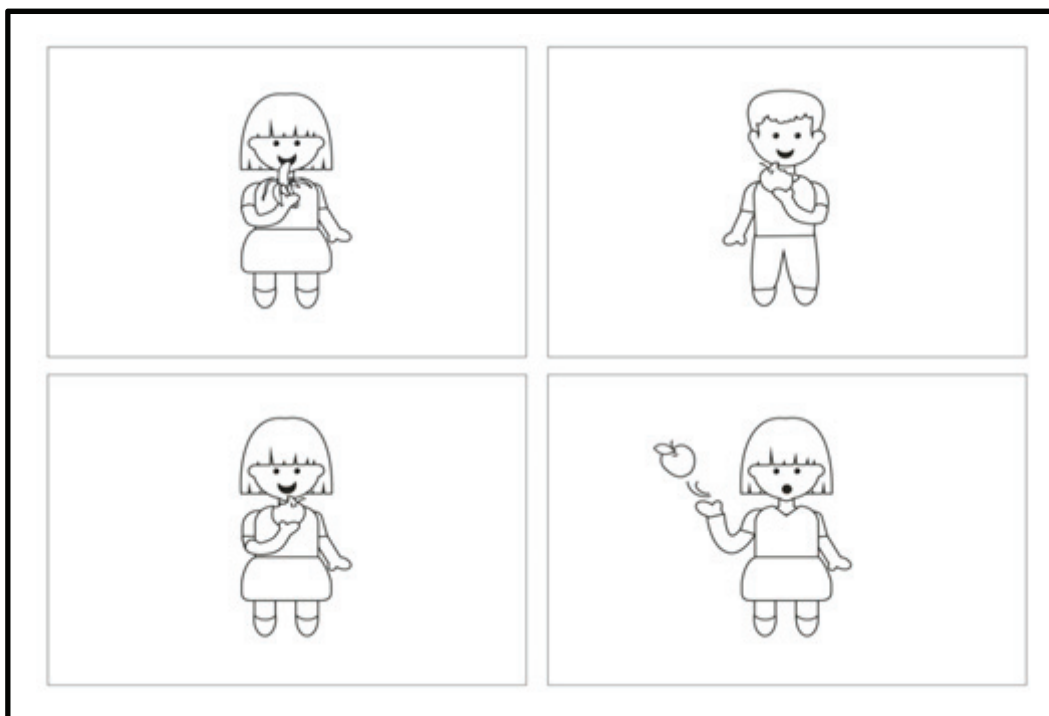

Exercice 13 (suite)

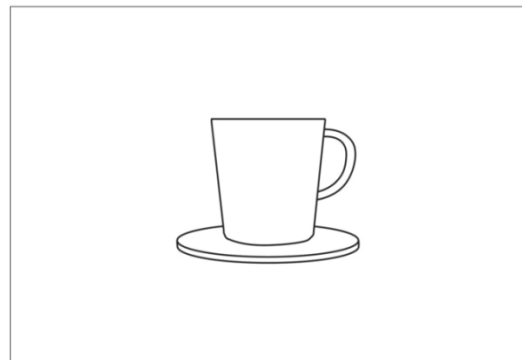
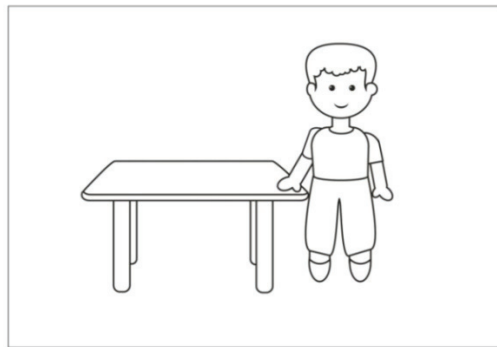
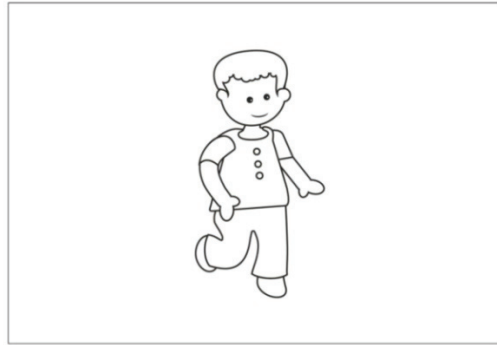
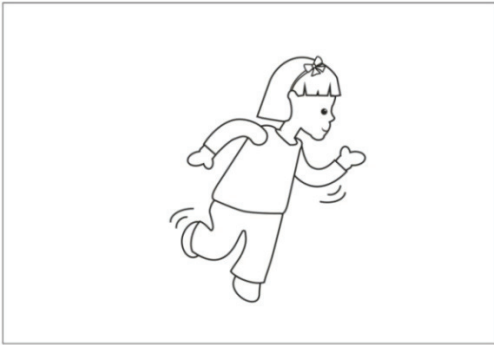

Exercice 13 (suite)

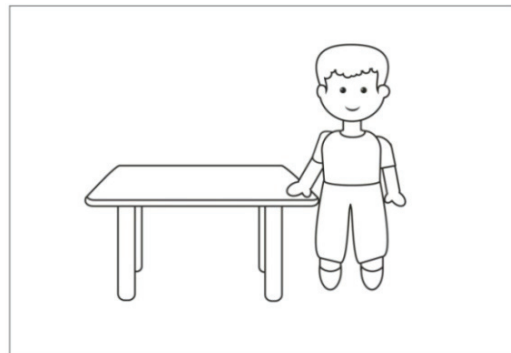
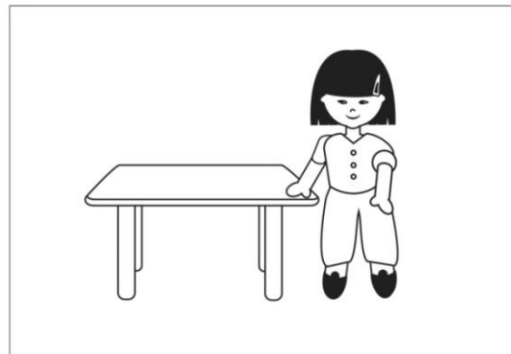
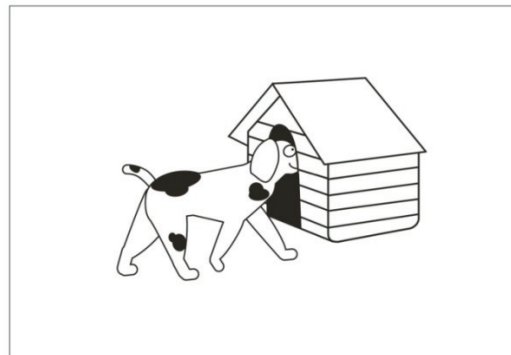
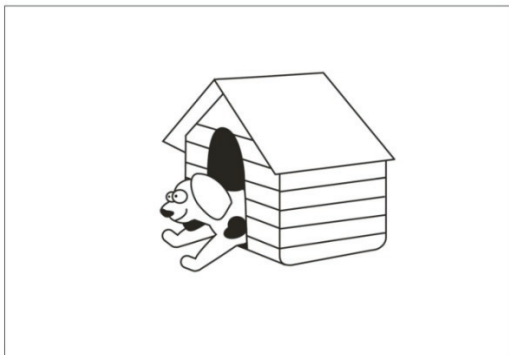
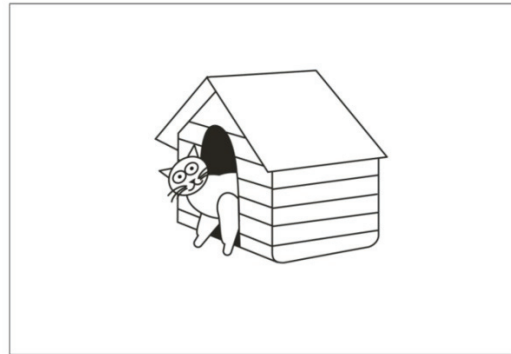
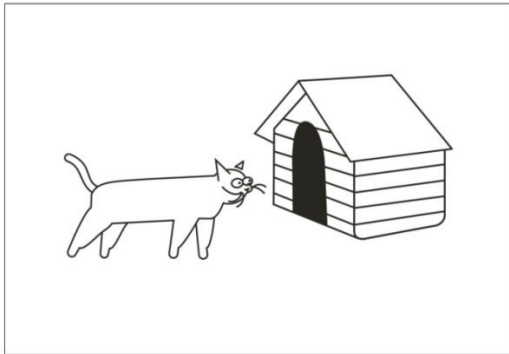

Exercice 13 (suite)

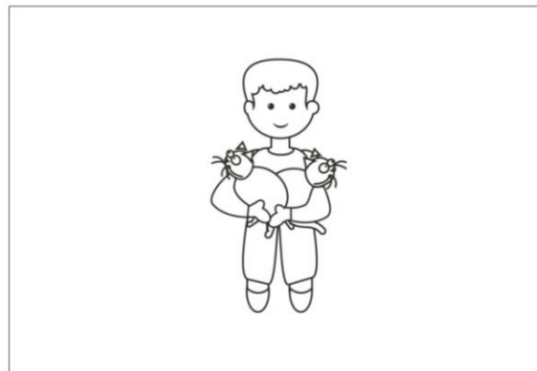
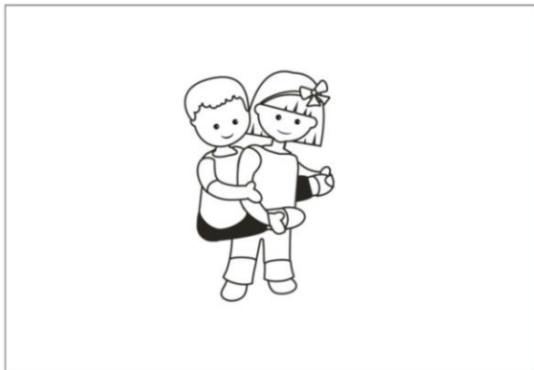

Exercice 13 (suite)

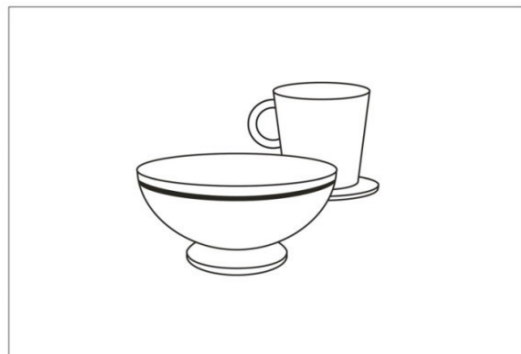
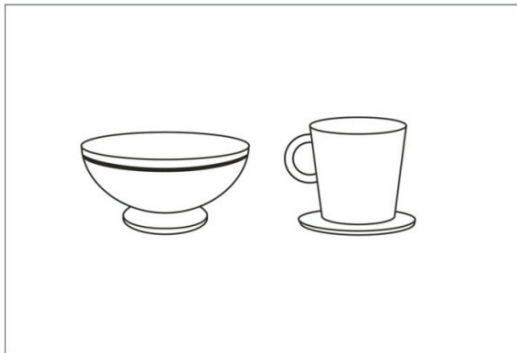
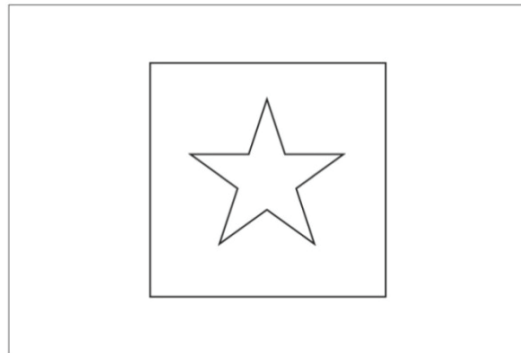
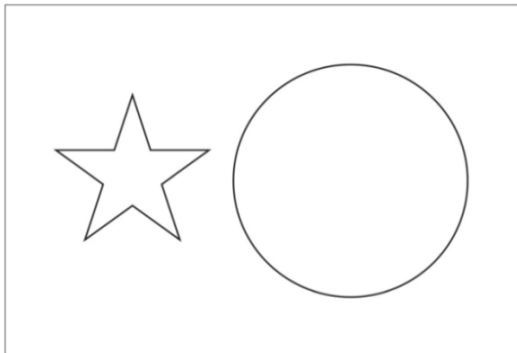
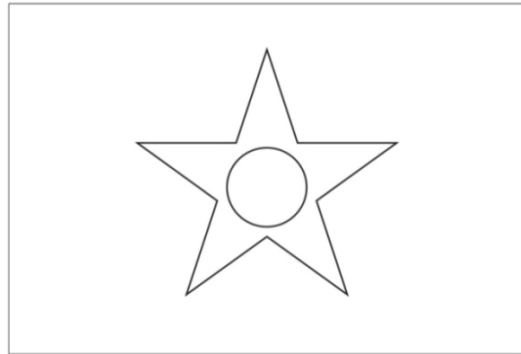
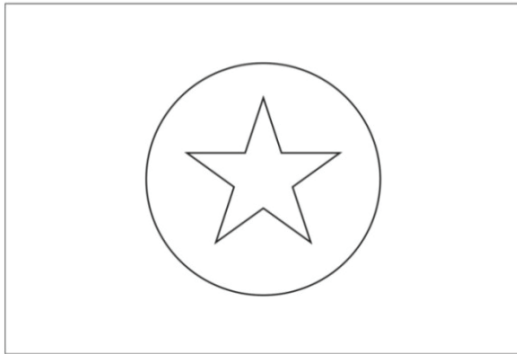

Exercice 13 (suite)

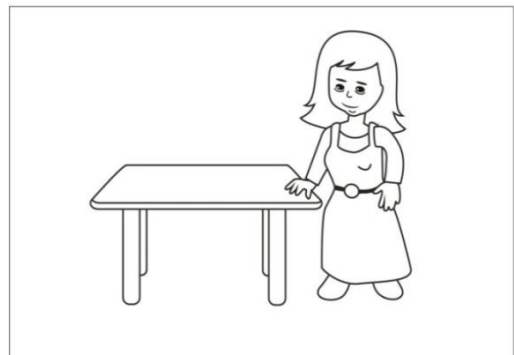
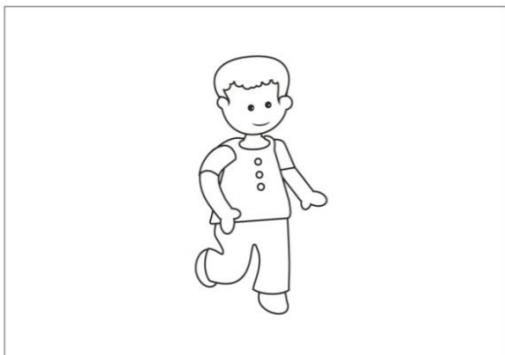
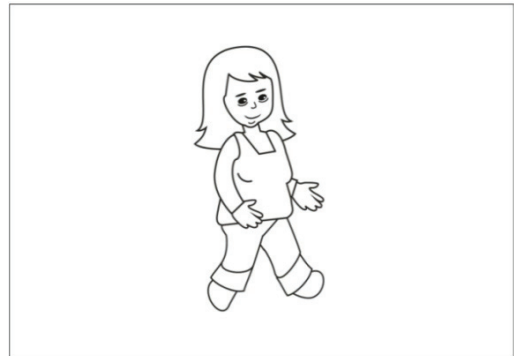
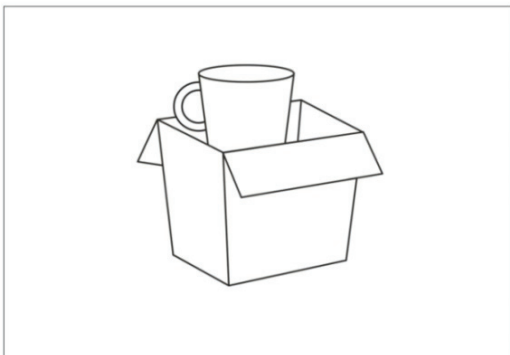
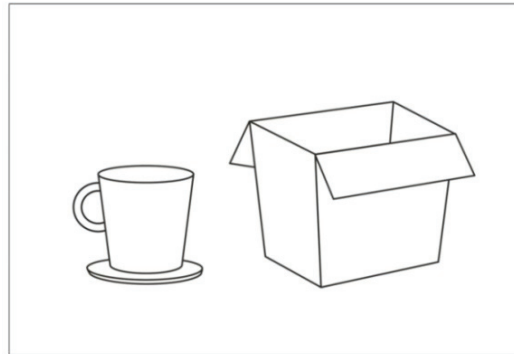
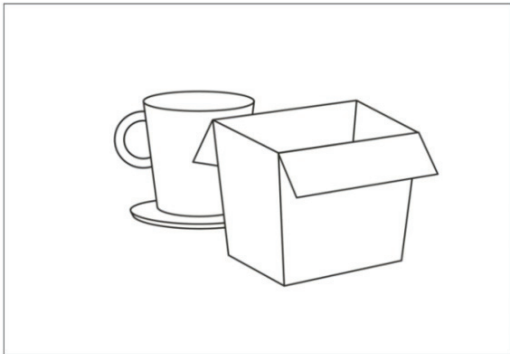

Exercice 13 (suite)

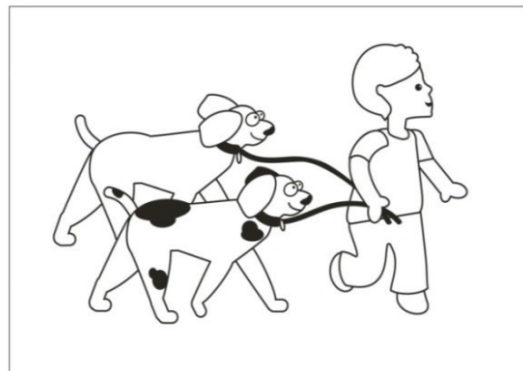
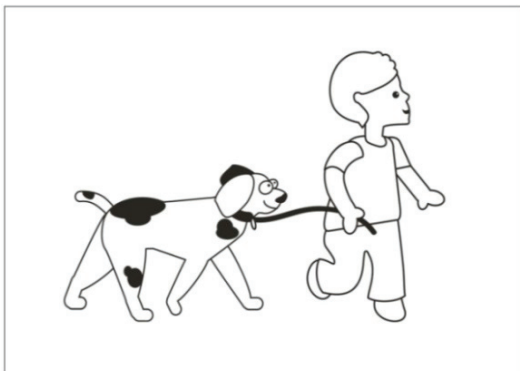
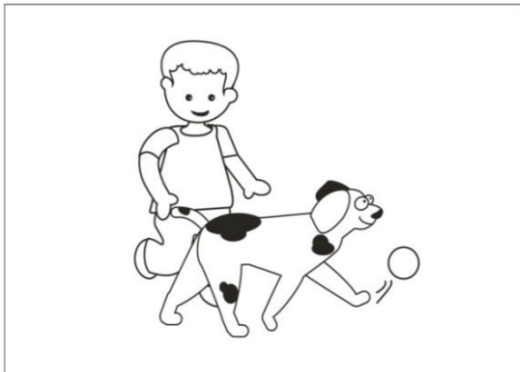
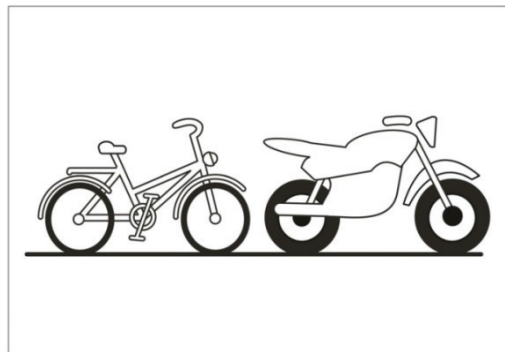
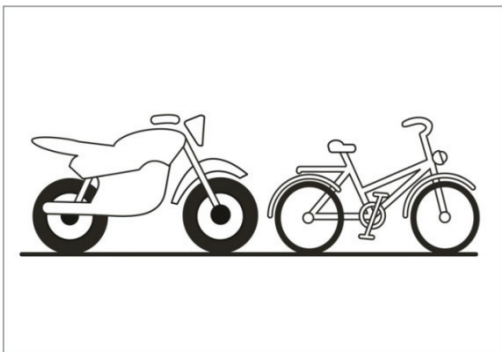
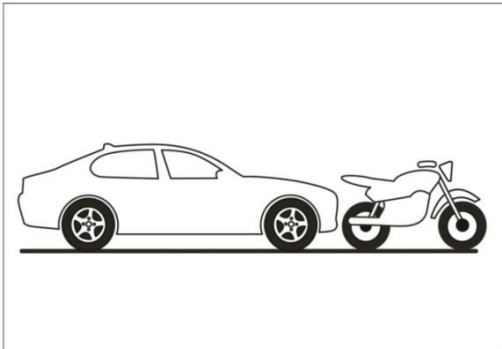

Exercice 13 (suite)

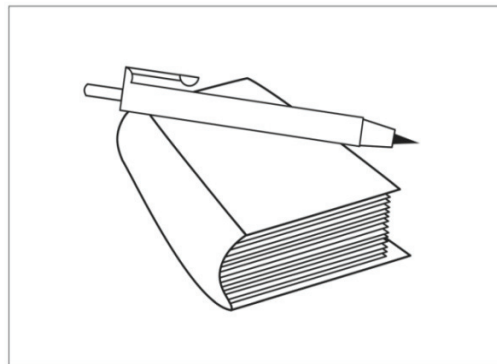
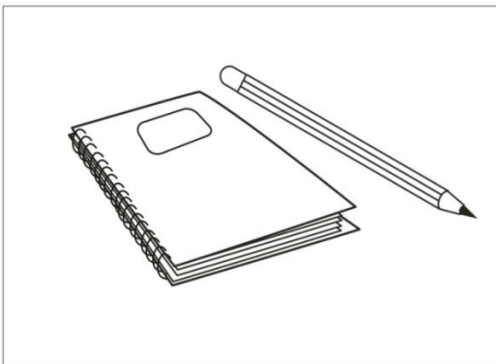
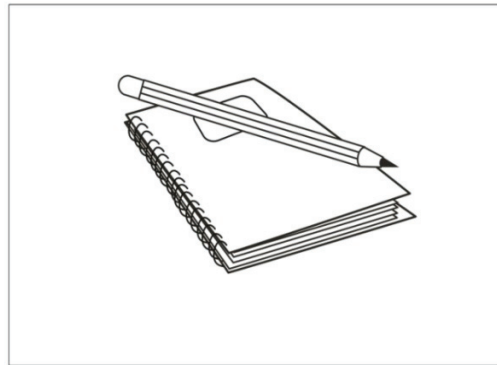
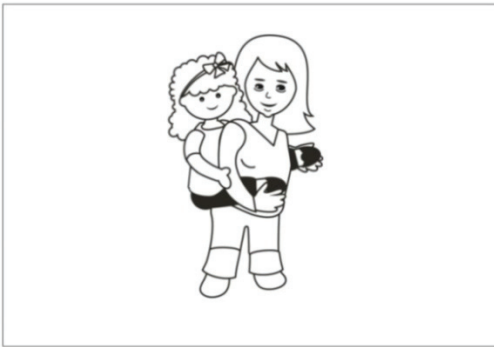
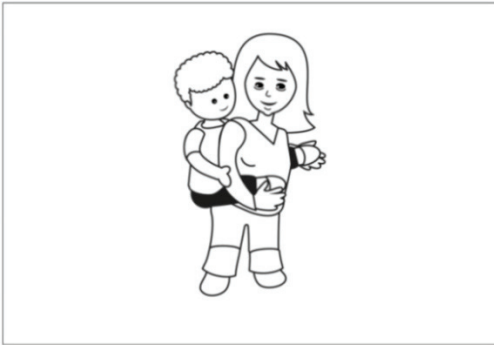

SÉQUENCE 4

MATHÉMATIQUES

Exercise 14

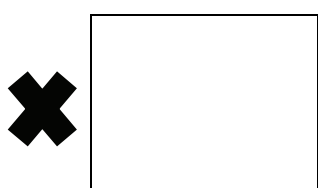
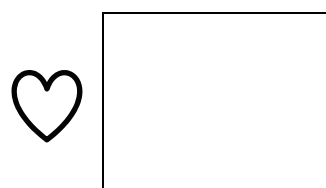
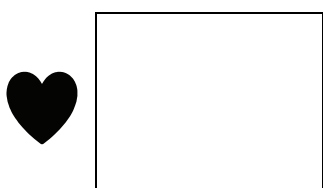
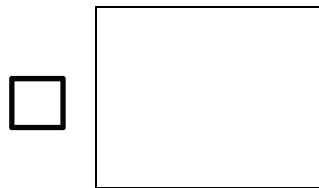
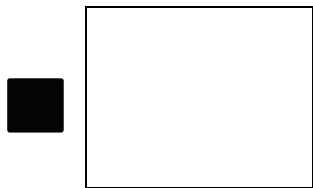
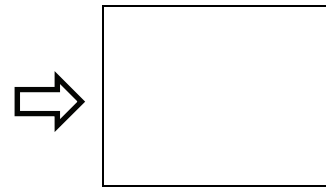
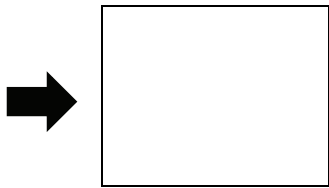
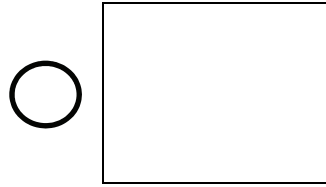
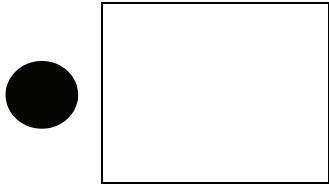

Exercise 15



1 2 3 4 5 6



1 2 3 4 5 6

Exercice 15 (suite)



--	--	--	--	--	--	--

1 2 3 4 5 6



--	--	--	--	--	--	--

1 2 3 4 5 6

Exercise 16

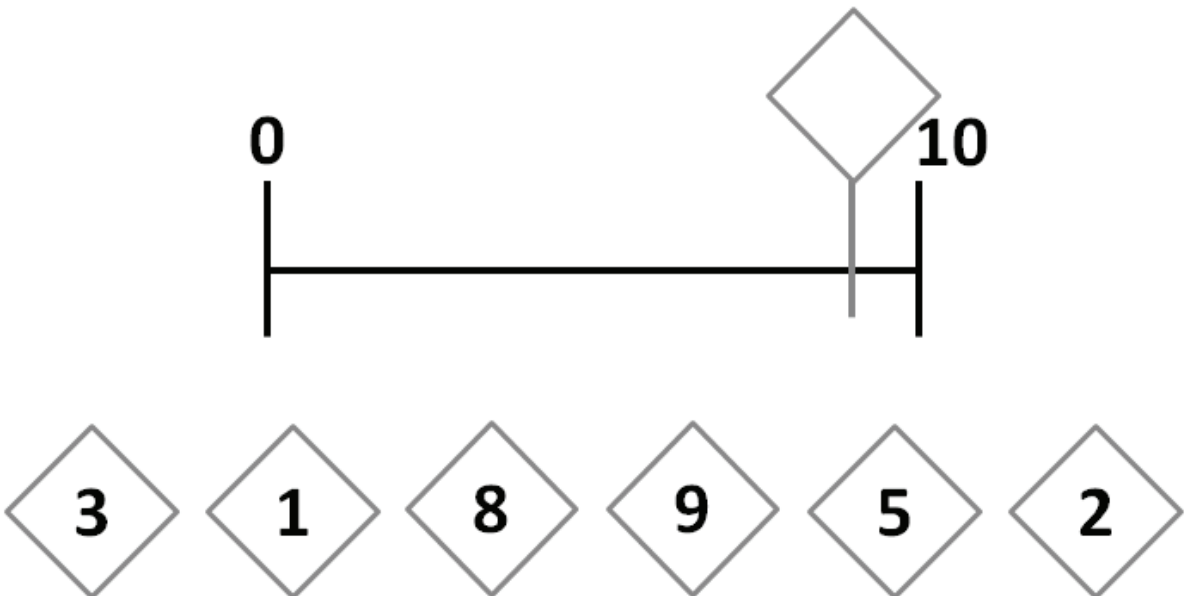
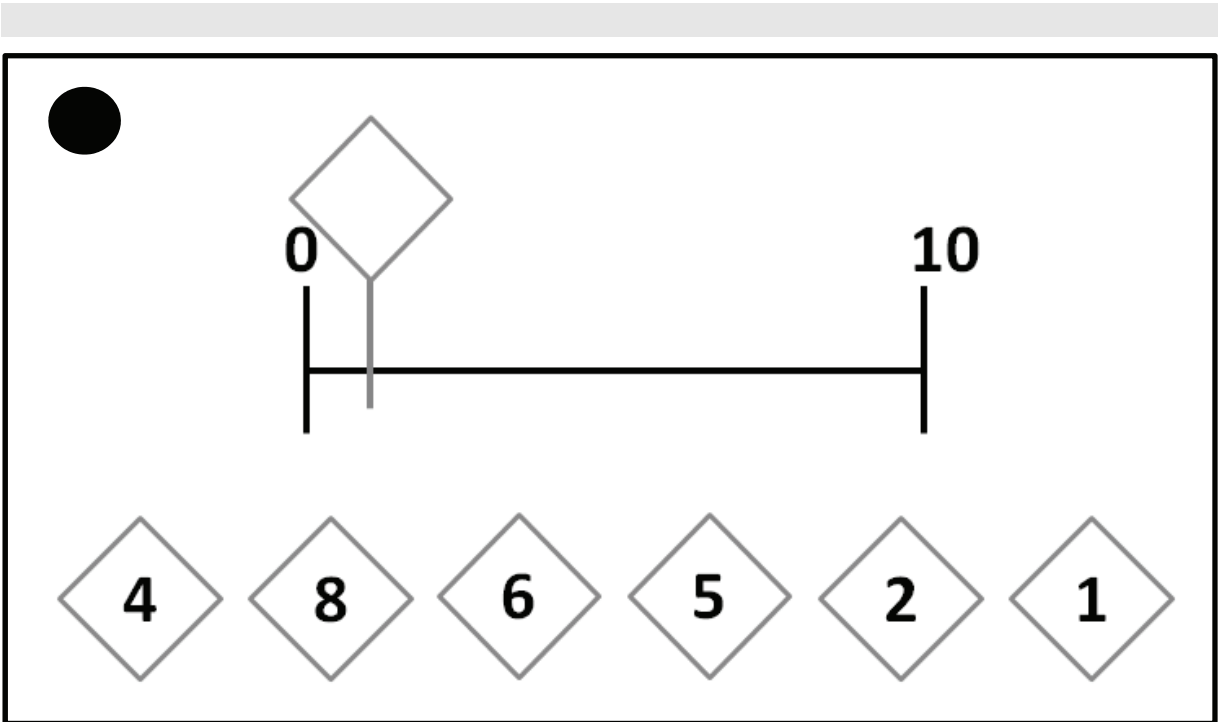

Exercice 16 (suite)

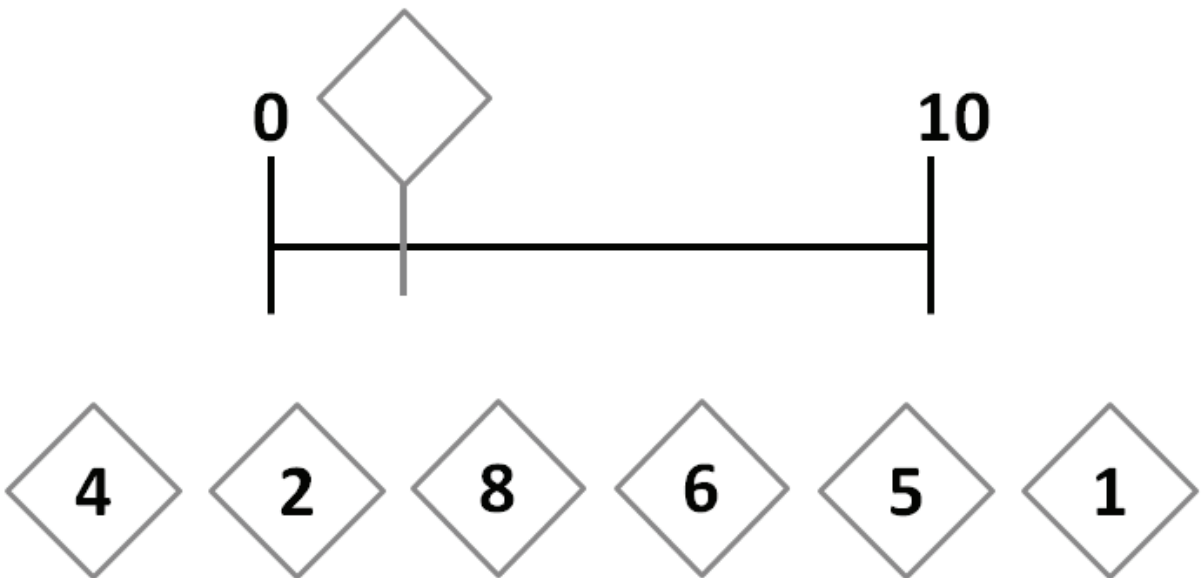
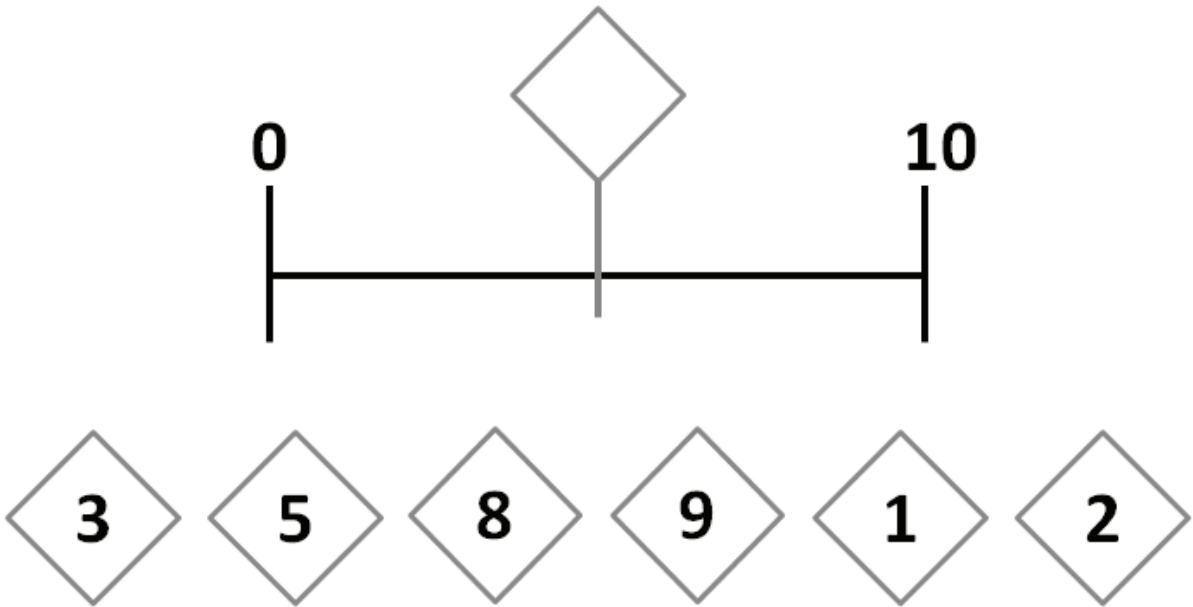

Exercice 16 (suite)

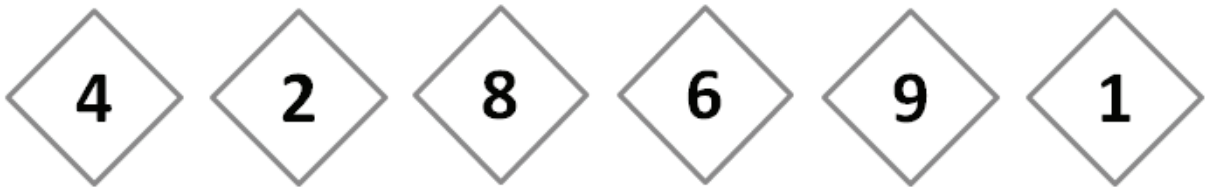
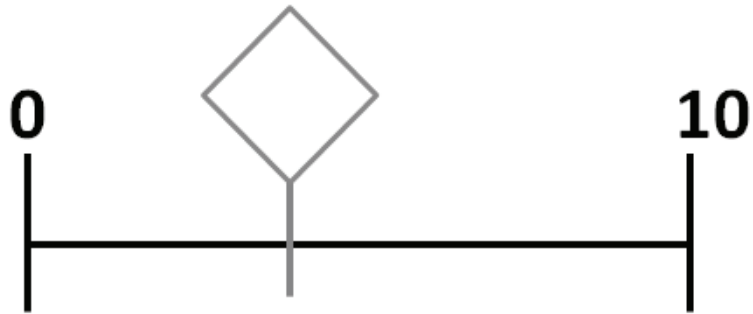

Exercice 16 (suite)

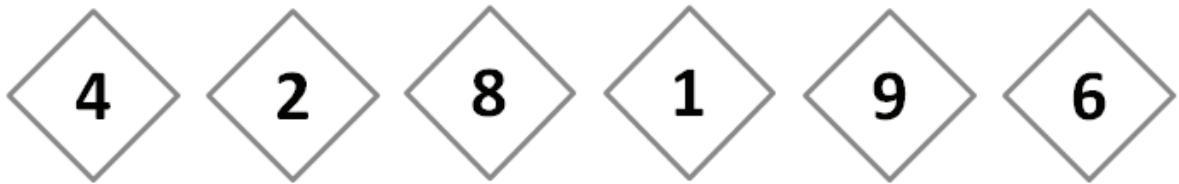
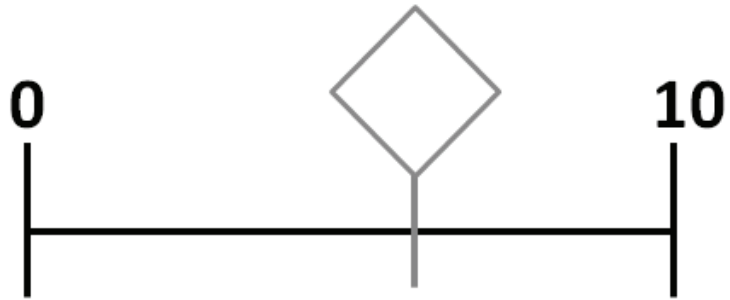

SÉQUENCE 5

FRANÇAIS

Exercise 17

● m n b d f

○ s r p t f

➔ m s r b d

⇒ m b d f j

■ l t d h f

Exercice 17 (suite)

 m b d f n

 h l v b d

 n m r t v

 n m r t s

 n d t s f

 n m v u f

Exercice 18

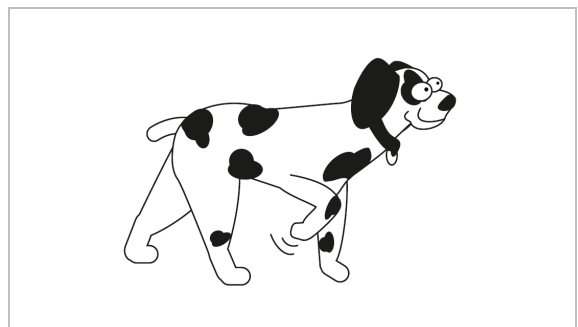
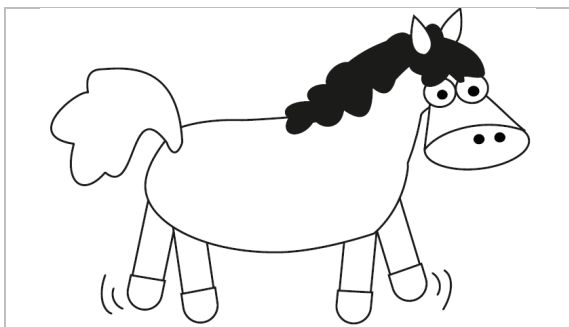
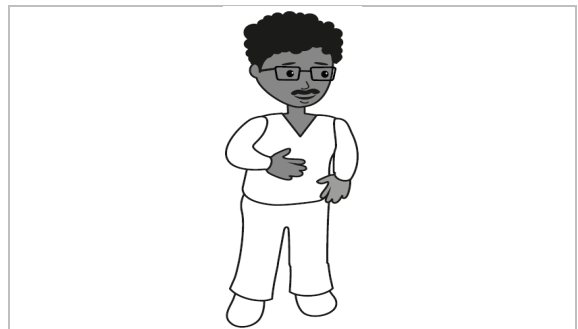
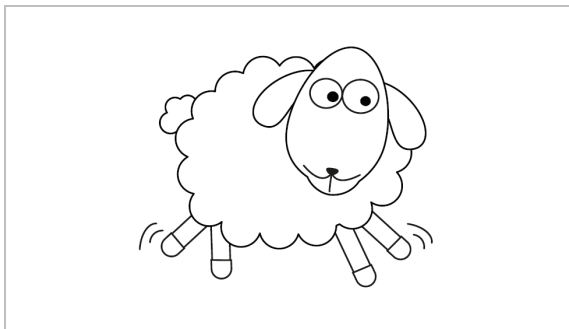
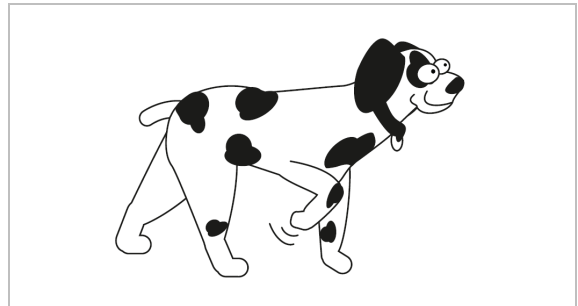
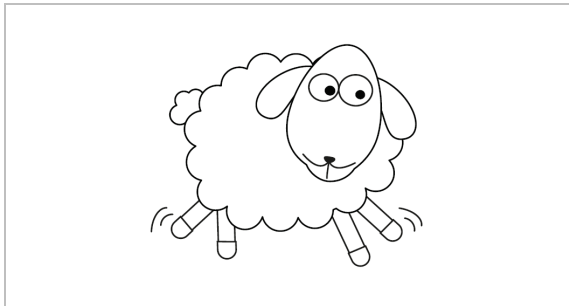
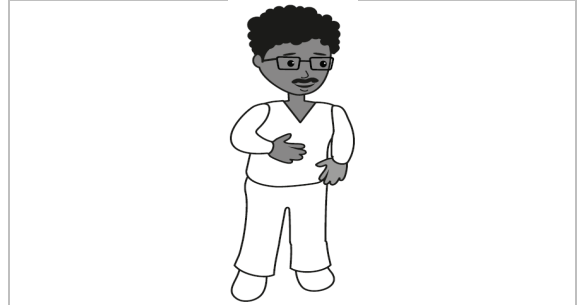
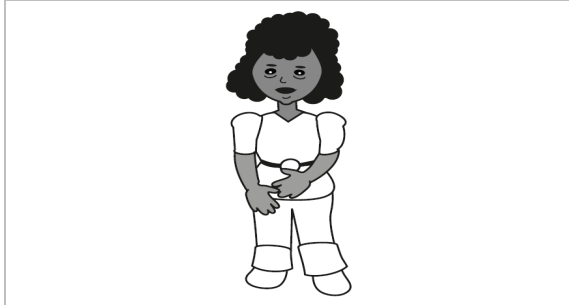

Exercice 18 (suite)

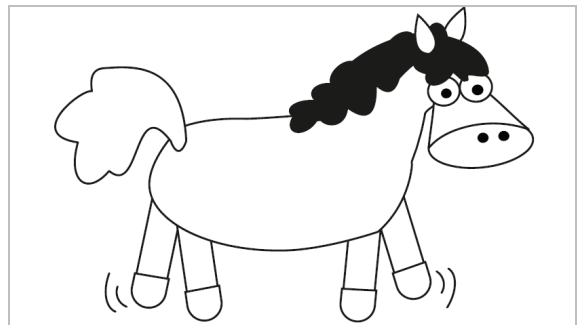
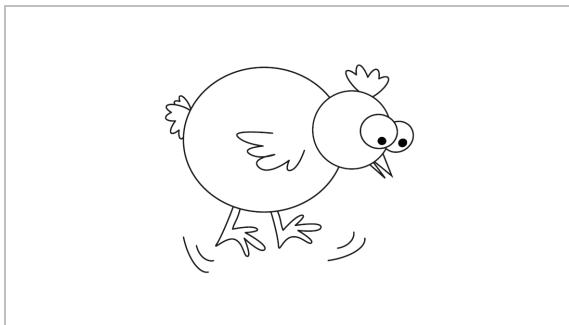
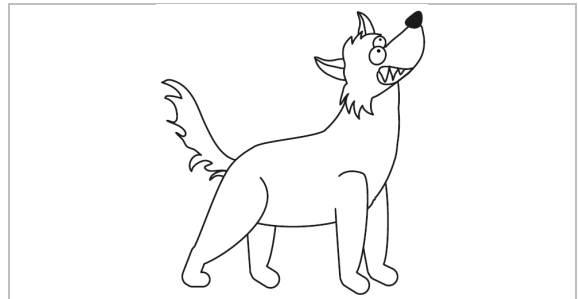
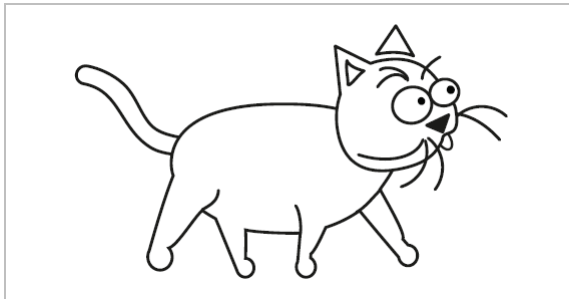
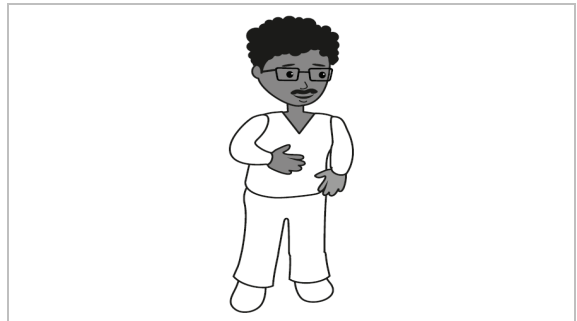
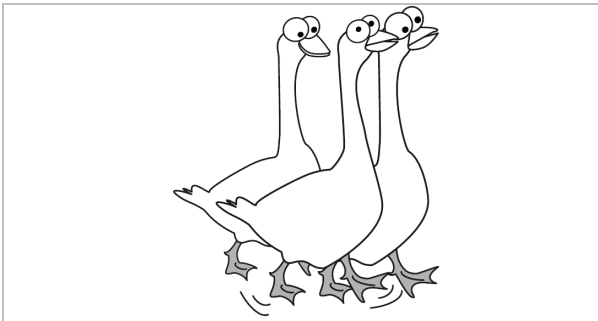
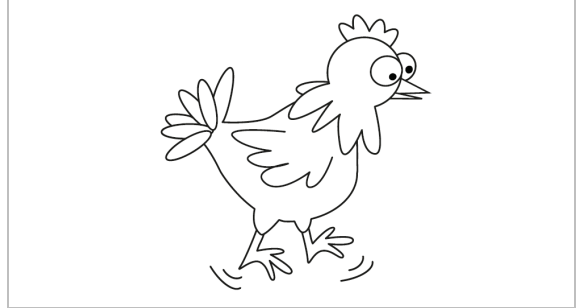
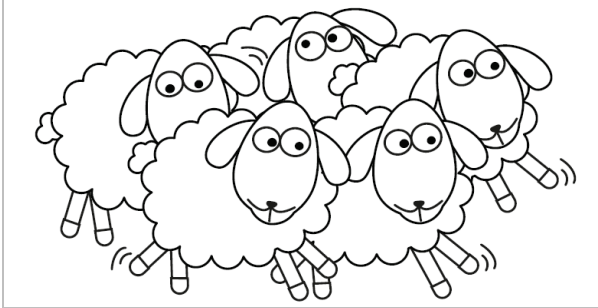

Exercise 19

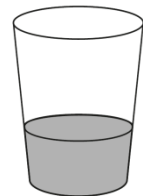
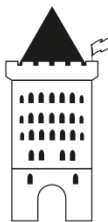
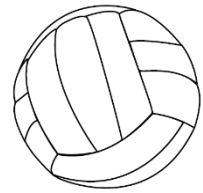
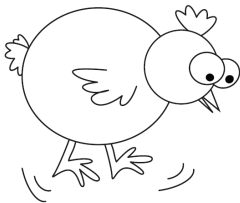
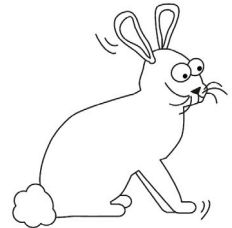
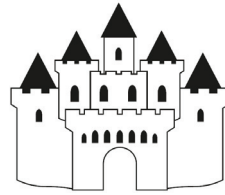
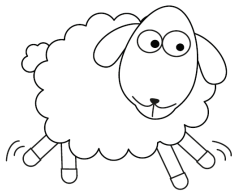
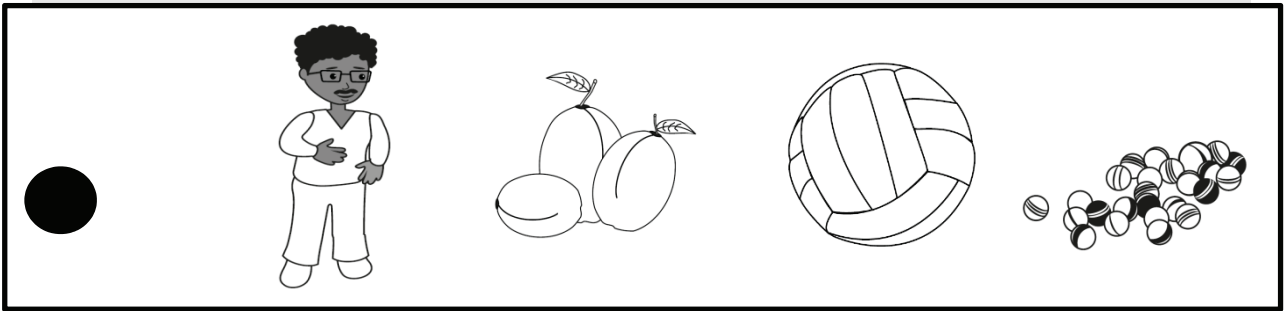

Exercice 19 (suite)

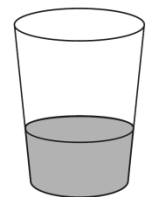
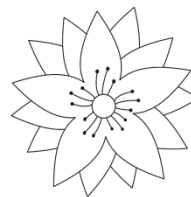
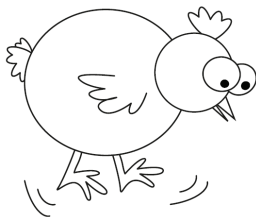
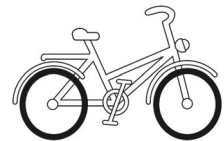
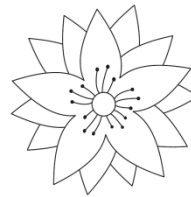
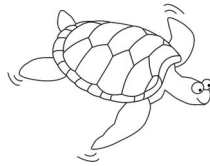
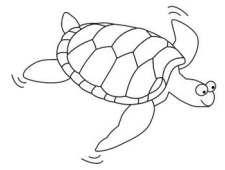
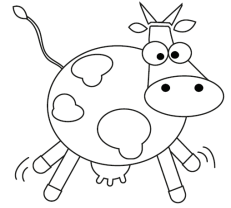
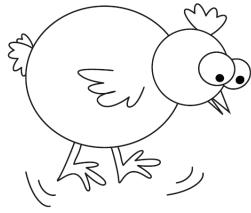

Exercise 20

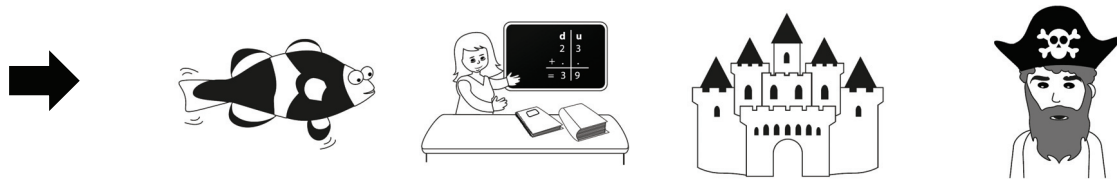
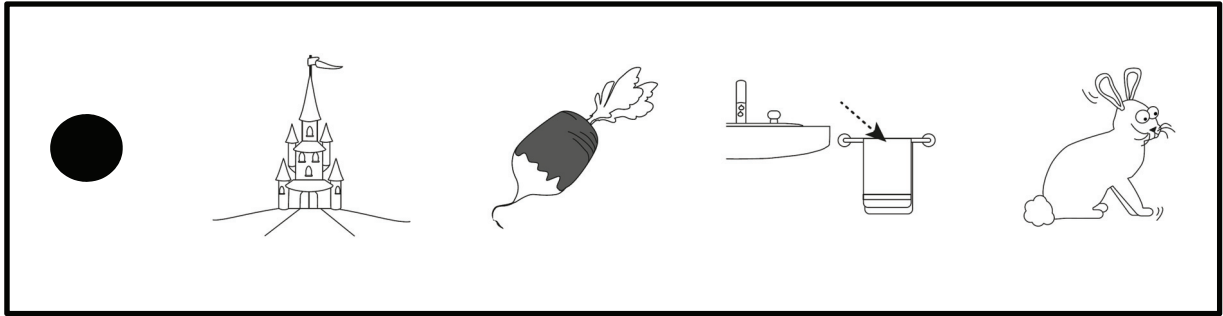

Exercice 20 (suite)

